

RoofStar Guarantee Standards for PVC Membrane Systems

How to use these Guarantee Standards

This Standard is comprised of fourteen (14) Parts that contain the Standards, Guiding Principles, Recommendations and Reference materials necessary for the design and installation of a Project to qualify for a **5 or 10-year RoofStar Guarantee**. Guarantee Standards specifically required to qualify for a **15-year RoofStar Guarantee** are listed in each relevant Part. All 15-year **RoofStar Guarantee Standards** must be read together with the general requirements for each Part in this Division.

Readers are advised to review relevant materials that can be accessed through the hyperlinks embedded in the body of text and visible in **blue font**. Part titles shown in blue indicate hyperlinks to more relevant material that the reader is advised to consult.

Content in each Part is colour-coded according to four classes, to assist the reader in understanding:

Standards

Guiding Principles

Recommendations

Reference materials

For definitions of these terms of reference, click [here](#).

Editor's note

The content of this Standard was significantly revised and supplemented in October 2018 and is effective December 1, 2019. Therefore, the reader should consider all content to be new since publication. Projects bid after October 30, 2019 must conform to the Standards published in this document.

Please note that the PDF highlights only the changes made since the last published revision of these Standards.

The reader is responsible to ensure that downloaded copies remain current with the online version of the Roofing Practices Manual. Only the online version of these or any other **RoofStar Guarantee Standards** shall be considered valid for the purpose of designing and constructing a RoofStar-qualified Project.

For all changes made since the last major revision (October 2019), consult the official online version of this Standard. In the event of a discrepancy between this PDF and the official online version of this Standard, the official online version shall be used.

1 GENERAL

1.1 References

In this *Manual*, all references to

- 1) the *British Columbia Building Code* or other standards presume the current edition that is in force.
- 2) materials are assumed to be Accepted by the RGC, unless stated otherwise.

1.2 Definitions

Assembly

means a *System* in combination with its supporting *deck* structure (adapted from *ASTM D6630-08 Standard Guide for Low slope Insulated Roof membrane Assembly Performance*).

Contractor

means the installer of a *Project*. For the purpose of issuing a **RoofStar Guarantee**, *Contractor* shall be read to mean an Active Member of the RCABC.

Design Authority

means the individual or firm responsible for the issuance of *Project* specifications and details to which the *Project* will be bid and constructed. When a *Contractor* designs a *Project*, the *Contractor* is deemed to be the *Design Authority*.

Finished Waterproofing/Water-shedding System

means the top surface of a *Water-shedding System* or *Waterproofing System* that may include ballast or that supports *Overburden*.

Guarantor

means the RGC **RoofStar Guarantee Program** that issues the **RoofStar Guarantee** (“*Guarantee*”); the two terms may be used interchangeably.

Linear Metal Flashings

are flashings cut and shaped from flat metal stock, to redirect water at roof perimeters and edges, and are used in valleys and drainage spillways.

Manual

means the **Roofing Practices Manual**.

Project

means the designed or constructed *Waterproofing System* or *Water-shedding System*.

System

means the organization and securement of various interacting materials (apart from the supporting *deck* structure), designed and installed to prevent the transmission of water through the *system* into the conditioned space of a building (adapted from *ASTM D6630-08 Standard Guide for Low slope Insulated Roof membrane Assembly Performance*).

Waterproofing System

means a membrane or liquid-applied *system* that, regardless of slope, waterproofs a roof or structure at grade. These *systems* are typically installed on slopes less than 1:4 (3” in 12”).

Water-shedding System

means a roof *system* that, with sufficient slope, sheds water away from a structure but does not necessarily waterproof it.

Refer to the [Glossary](#) for further definitions of key terms used in this *Manual*.

1.3 Design

1.3.1 RoofStar 15-Year Guarantee

- 1) To qualify for a **RoofStar 15-year (Waterproofing Roofs) Guarantee**, each *Project* must be designed and constructed in compliance with both the **RoofStar Guarantee Standards** and the membrane manufacturer's 20-year Material Warranty standards.
- 2) The *Contractor* must apply to the membrane manufacturer for their 20-year *System Warranty* standards.
- 3) Where enhanced roof *system* securement is required by the manufacturer, which may exceed the securement required in a *Tested Assembly*, an *Assembly with Proven Past Performance* or a custom-engineered securement, the higher securement requirements must be complied with.

1.3.2 System Types

Designing a good roof begins with the end in mind and an answer to the essential question, "What purpose will the roof serve?" For example, the roof may

- simply weatherproof the building interior.
- provide a location for building equipment and services.
- support liveable spaces.

Each of these functions may limit the choice of membrane assembly.

There are four principal *Waterproofing Systems* used on roofs. See full definitions under **1.3.2.1** and **1.3.2.2**:

- 1) *Uninsulated Systems* (insulation may be installed beneath the *deck*).
- 2) *Conventionally Insulated Systems* (sometimes referred to as *Compact Roofs*).
- 3) *Protected Membrane Roof Systems* (also referred to as "inverted").
- 4) *Modified Protected Membrane Roof Systems*.

Of course, sometimes the roof *deck* influences these choices. Regardless of the *Design Authority's* starting point, knowing where you are going is the beginning of a successful design.

Regardless of the *system* type, the *Finished Waterproofing System* is defined by whatever is placed on the membrane, which may be insulation, ballast, pavers or overburden. These materials will displace water and therefore affect the height of membrane flashing needed to prevent water ingress. The definition of *Finished Waterproofing System* is illustrated below in **Figures 1.3.2-1** and **1.3.2-2**. See also **1.2 Definitions**.

Figure 1.3.2-1 (Conventionally Insulated Waterproofing System)

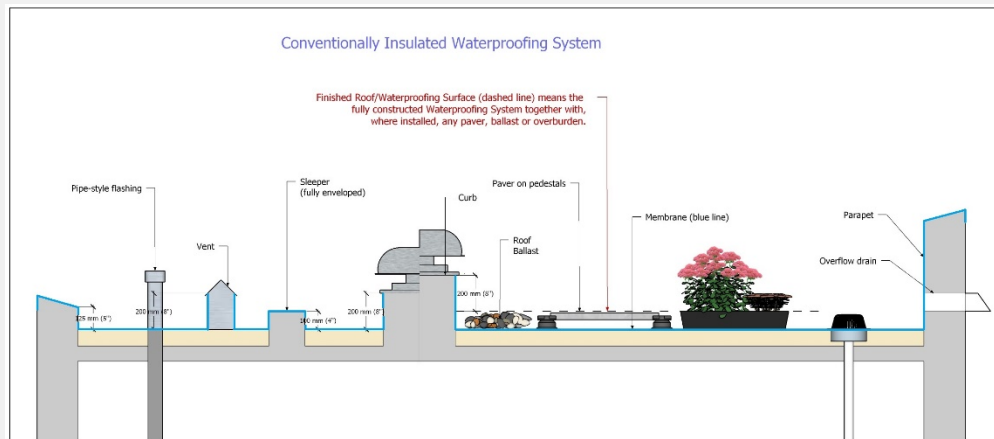
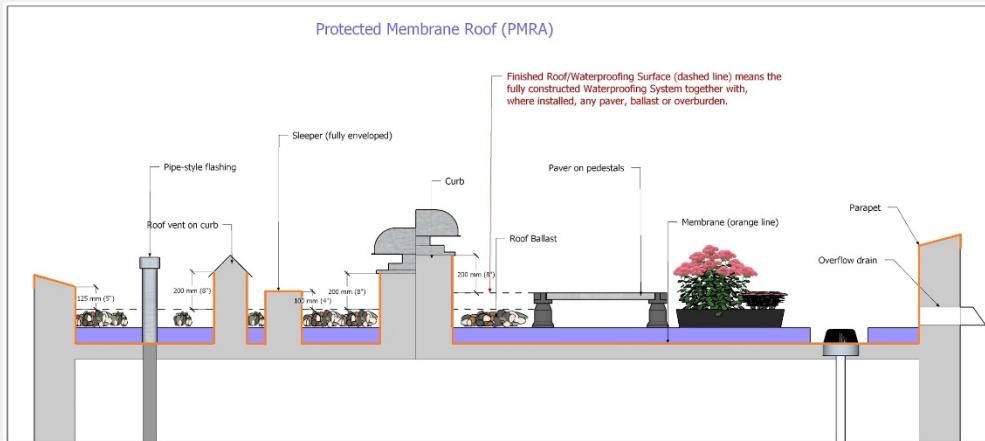

Figure 1.3.2-2 (Protected Membrane Roof System)



1.3.2.1 Conventionally Insulated Systems

- 1) In a *Conventionally Insulated System*, the membrane is the final layer, exposed to the weather. It protects the other roofing components, including insulation, from exposure to water, wind and other weather conditions. *Conventionally Insulated Systems* are classified in this *Manual* by three different methods of attachment (securement) to the roof deck:
 - 1) **Mechanically Attached Roof Systems (MARS)**
 - 2) **Partially Adhered Roof Systems (PARS)**
 - 3) **Adhesive Applied Roof Systems (AARS)**

More about these three systems is offered in **3 SECURING the ROOF ASSEMBLY**.

1.3.2.2 Protected and Modified Protected Membrane Roof Systems

NOTE: See more information on [Protected and Modified Protected Roof Systems](#) in [Division B: Essential Elements](#).

- 1) In a *Protected Membrane Roof Systems* (or *Protected Membrane Roof Assembly*, also called *PMRA*) the membrane is applied directly to the *supporting deck* structure or the *deck overlay* (as required and/or specified), and protected from the elements, and from damage, with insulation and an overburden. In this way, the membrane functions both to waterproof the roof and control air or vapour. Only RoofStar-accepted Extruded Expanded Polystyrene, or XPS, (conforming to *CAN / CGSB-51.20-M87*, Type 4) is acceptable for a *PMRA*. XPS is water-resistant (i.e. resistance to water absorption, moisture transfer, and capillary action), freeze-thaw cycling resistant, and possesses a high compressive strength. If a drainage layer is specified, it is typically installed between the membrane and insulation. An additional drainage layer may be installed above the insulation, together with a filter fabric mat and ballast or overburden. These three components - a drainage layer, filter fabric and ballast - promote controlled drainage, resist infiltration of contaminants, resist the lifting forces of wind, and counteract the natural buoyancy of the insulation.
- 2) *PMRA*'s are the required roof assembly design for certain types of overburden. See **14.1.2 Design for RoofStar Guarantee Standards**.
- 3) A *Modified Protected Membrane Roof System* (or *Modified Protected Membrane Roof Assembly*, also called *MPMRA*) is similar to a *PMRA* except that a layer of insulation is installed underneath the membrane as well as on top. This may offer cost savings as only the top layer of insulation requires ballast and the bottom layer (mechanically fastened or adhered) need not be Extruded Expanded Polystyrene and may be tapered to provide slope. As a **general** rule, two-thirds or more of the total thermal resistance (RSI or R value) should be above the membrane, but in **all cases** the *Design Authority* should perform the required psychrometric calculations before designing a roof system.

1.3.3 Accessibility for Maintenance

1.3.3.1 RoofStar 15-Year Guarantee

- 1) On all new construction *Projects*, where external access is not provided, all roofs with a field elevation greater than 7500 mm (25') above grade must incorporate safe, appropriate access to the roof, for example by incorporating stairs and a doorway or a properly located roof hatch. These requirements are recommended for existing buildings to facilitate maintenance and ongoing performance reviews.

1.3.3.2 All Projects

While the **RoofStar Guarantee Standards** pertain to the design and construction of a leak-free roof, accessible design is still critical since a roof must be regularly maintained. Therefore, while the following list is not exhaustive, the *Design Authority* is urged to consider these guiding principles when designing a roof *Project*.

- 1) All roofs with a field elevation greater than 7500 mm (25') above grade should incorporate access to the roof by stairs and a doorway or with a properly located roof hatch.
- 2) Any hatch, ladder or mechanical unit should be located a sufficient distance away from the roof edge (setback zone) so that other fall protection measures are not required by those using or accessing this equipment. When it is not possible to situate a hatch, ladder or mechanical unit outside the setback zone, guard rails should be designed for the roof edge to provide additional fall protection for those using or accessing such equipment.
- 3) Each roof should be designed to provide safe access for maintenance of roof drains, corners or mechanical equipment, where the roof is at least 3 m (10') above the surface of the ground, or where a hazard to a person exists, should a fall be possible. This principle also applies to roof areas intended for regular occupancy. Therefore, provide fall protection in compliance with the Building Code having jurisdiction, and with the Workers Compensation Act Regulations, by designing appropriately located
 1. tall parapets.
 2. guardrails.
 3. tie-off anchors.

1.3.4 Waterproofing Integrity Scans and Electronic Leak Detection

An integrity scan is performed after the installation of the waterproofing roof *system*, before any overburden, equipment or amenity space is installed on top of it. An integrity scan typically uses low-voltage electrical current to detect even the smallest breaches in the roof membrane, but some waterproofing materials may require the use of other technologies in order to verify the roof *system's* integrity. Therefore, *Design Authority* should specify the appropriate technology, keeping in mind the limitations of each scan and detection methodology, and of the membranes that are specified.

Electronic Leak Detection (ELD) utilizes low-voltage electrical current, typically conducted through wires installed in a grid pattern, and are used in response to a leak, to isolate its location in order to minimize investigation time and material removal. This can benefit a building owner who will have to bear the costs of demolition or overburden removal when the standard limits of coverage afforded by the **RoofStar Guarantee** are exceeded by the *Project* design and construction. ELDs may be passive (installed but not monitored) or actively monitored (by the installer, through real-time data collection).

- 1) Flood testing (as an alternative to an integrity scan) is not recommended. When flood testing is specified, testing shall be conducted prior to installation of insulation and roof coverings and must be performed to ASTM D5957.
- 2) Neither an integrity scan nor an Electronic Leak Detection (ELD) system are considered Accepted Materials, but firms that provide these services are nevertheless specifically recognized and approved by the **RoofStar Guarantee Program**.

- 3) An integrity scan is required for some *Projects* (see **1.6 RoofStar Guarantee: Coverage and Limitations**), but is nevertheless strongly recommended before the completed roof assembly is covered with overburden, equipment or living (amenity) spaces (see **14.1.2.1**).
- 4) Electronic Leak Detection is required for all *Waterproofing Systems* installed at grade, and while it is optional for *Waterproofing Systems* on roofs, installed electronic leak detection is strongly recommended
 - 1) for *Projects* where multiple trades will have access to a roof that is under construction and completed, in order to identify breaches in the waterproofing membrane in a timely way and avoid future costly delays.
 - 2) when the roof assembly protects a sensitive occupied space (i.e. data centres, hospitals, critical infrastructure).
 - 3) when the roof supports any type of *Overburden*, equipment or living (amenity) space.
- 5) When Electronic Leak Detection is specified, it should provide detection capabilities for the entire waterproofing, and should extend at least 50 mm (2") vertically from the water plane at
 - 1) all transitions.
 - 2) any point along the entire *deck* perimeter.
 - 3) protrusions.

1.3.5 Hot Works: Design

When any portion of a waterproofing *system* is installed with heat, the work is classified as Hot Work. Some tools used in the course of Hot Work can ignite combustible materials, and some building environments are more sensitive to fire than others, such as a building containing or in close proximity to flammable liquids. Hot work may occur during

- tear off (sparks).
 - *deck* preparation (drying wet surfaces).
 - cold temperatures (warming materials or surfaces).
 - equipment use (sparks within electrical tools, or from cutting, drilling or grinding metal, concrete, stone or other hard surface products).
 - membrane installation (with the means of a kettle, hot-air welder or open flame torch).
- 1) The *Design Authority* may specify that the contractor must maintain compliance with the RCABC Hot Work Program and consequently manage the Hot Work conducted on site.
 - 2) When the *Project* involves Hot Work, the *Design Authority* must either
 - 1) pre-approve alternate applications already written within the *Manual* when the specified application is deemed to be fire sensitive by the *Contractor* as part of the risk assessment process.
 - 2) provide alternate material and application requirements in the Specification for fire sensitive locations on the *Project*.

See also **1.4.3 Hot Works: Contractor Requirements**.

1.3.6 Variances

When a design is unable to conform to the Standard, the *Design Authority* may apply to the RGC for a written Variance. Application must be made in writing (email correspondence is common), and the request must

- 1) identify the *Project* name, its civic address and the applicable **RoofStar Guarantee** number (if already initiated).
- 2) articulate the nature of the design problem.
- 3) cite the **RoofStar Guarantee** standard reference to which the Variance will apply.
- 4) provide design drawings (and photographs, if available) as supporting information.

We may ask for more information in order to fully consider a request for a Variance and will issue a completed Variance only to the *Design Authority* for distribution to the *Contractor*.

A Variance may be unrestricted in its scope, or it may include one or more conditions that will affect the design and construction of the *Water-shedding System* or *Waterproofing System*, in order to accommodate the varied Standard. Occasionally, a Variance may also restrict coverage offered by the **RoofStar Guarantee**.

Variances are issued only for the specific issue on the *Project* identified in the written request, and do not constitute general permission to depart from the published Standards in this *Manual*, for any aspect of the same *Project* or for future *Projects*, designed or constructed by any other firm.

1.4 Scope

The **Guarantee Standards**, Guiding Principles, Recommendations and Reference Materials in this *Manual* pertain to both new roofing construction and replacement roofing, unless explicitly stated otherwise.

1.4.1 New Construction

New roof construction must utilize only newly manufactured materials, and may not incorporate recycled products, unless with the expressed, written consent of the **RoofStar Guarantee Program**.

1.4.2 Replacement Roofing and Additions

As a roof ages, is neglected or is damaged, it may lose its ability to perform reliably and effectively, necessitating replacement. Replacement roofing, also referred to as "re-roofing," whether made in whole or in part, should be undertaken with the Quality Assurance and Quality Control provided for under the **RoofStar Guarantee Program**. Regardless of the approach to replacement roofing, the existing *deck* structure must meet the pullout resistance rating for mechanical fasteners and must be capable of supporting all dead and live loads. Furthermore, the *deck* must be capable of supporting any additional dead loads of the new roof *system*.

Three types of replacement roofing are contemplated and permitted (with varying degrees of limitations and conditions) under the **RoofStar Guarantee Program**:

- **System Replacement** - removal and replacement of all roof *system* components, except for the supporting *deck* structure.
- **Membrane Replacement** – removal and replacement of the roof membrane, while retaining existing roof *system* components (i.e. insulation, ballast).
- **Recovering** - installation of a new membrane over an existing membrane, while retaining some or all of the other roof *system* materials (NOTE: Recovering is permitted only with a written Variance issued by the **RoofStar Guarantee Program**).

Qualifying and construction conditions and limitations for each of these replacement options are described below. Other conditions and limitation may be determined by the **RoofStar Guarantee Program** administration subject to the nature and specifications of the Replacement Roofing *Project*.

1.4.2.1 System Replacement

- 1) Roof *system* replacement means the complete removal and replacement of all roof *system* and metal flashing materials, exclusive of the air or vapour control layers (see **1.4.2.1 (2)** below). Only new replacement materials are permissible. The design of the replacement roof *system*, and the installation of new materials, must conform to the **RoofStar Guarantee Standards** for new roof construction, unless expressly varied elsewhere in this Standard (see, for example, alternate slope requirements and recommendations in **2.2.3 Replacement Roofing**).
- 2) Subject to the requirements in **Part 6 AIR and VAPOUR CONTROLS**, the decision to reuse and repair an existing air or vapour control layer remains the responsibility of the *Design Authority*.
- 3) *System* replacement *Projects* qualify for all types of a **RoofStar Guarantee**.

1.4.2.2 Membrane Replacement

1.4.2.2.2 RoofStar 15-Year Guarantee

- 1) In addition to the **General Requirements** for Membrane Replacement outlined below, a *Project* designed to qualify for a **RoofStar 15-year Guarantee** must
 - 1) be supported by the following, submitted in report form to the *Guarantor* for review and consideration prior to tender:
 - 1) moisture survey scan performed by a qualified person.
 - 2) at least three (3) cut tests for roof areas up to 20,000 sf (200 squares), or one (1) cut test for every 2000 sf (20 squares), whichever is more.
 - 3) one (1) cut test for every 3000 sf (30 squares) of roof area that exceeds the first 20,000 sf (200 squares).
 - 4) one (1) cut test for each small roof area measuring no more than 200 sf (2 squares)
 - 2) incorporate new insulation overlays in keeping with the requirements published in **Part 8 INSULATION OVERLAYS**.

1.4.2.2.2 General Requirements

Membrane replacement is a partial roof *system* replacement, limited to the membrane or materials adhered to the membrane. A written Variance is not needed for this type of *Project*, but for membrane replacement to qualify for a **RoofStar Guarantee**,

- 1) the *Design Authority* must be certain the existing roof *system* is properly secured to the existing *deck* structure (see **Part 3 SECURING the ROOF ASSEMBLY**).
- 2) the existing roof *system* must be demonstrably dry and free of any wet materials (wet materials must be replaced, in order to qualify for a **RoofStar Guarantee**).
- 3) the existing field membrane must be removed and replaced with a new insulation overlay board and a new membrane.
- 4) existing membrane flashing must be removed and replaced with new materials.
- 5) the design must comply with the **RoofStar Guarantee Standards** for new roof construction.

1.4.2.3 Recovering

Recovering - installing a new membrane over an existing membrane - is permitted in certain circumstances for a five (5) or ten (10) year **RoofStar Guarantee**, **though it is not a recommended practice and will limit the scope of coverage for the RoofStar Guarantee**. Recovering does not qualify for a **RoofStar 15-year Guarantee**.

Qualifying for a **RoofStar Guarantee** is subject to the Conditions and limitations listed below and is permitted only with a written Variance issued by the *Guarantor*. A **RoofStar Guarantee** issued for a recovered roof is limited strictly to the value of new roof *system* materials; existing materials that remain in place beneath new materials do not qualify for coverage under the **RoofStar Guarantee**.

1.4.2.3.1 Recovering: *Project* Qualifications

Any Variance permitting roof recovering must be applied for in writing by the *Design Authority*, addressed to the **RoofStar Guarantee Program** prior to the tendering of documents. To qualify for a Variance, the following conditions must be met and confirmed in the written application:

- 1) The new roof *system* must be properly secured to the existing *deck* structure (see **Part 3 SECURING the ROOF ASSEMBLY**).
- 2) The existing roof *system* must be distinct and physically separate from other roof areas.
- 3) The request for a Variance must identify the type of roof *system* - *Conventionally Insulated, Protected Membrane Roof System* or *Modified Protected Membrane Roof System*.
- 4) Conventionally Insulated Systems only: The existing roof *system* must be independently surveyed by qualified professionals using calibrated moisture detection equipment and cut tests, and the resulting survey shall be formally documented for review by the **RoofStar Guarantee Program** administration. Where electronic

moisture detection identifies wet roof *system* material, the following requirements for cut tests apply, based on roof area. All cut tests shall be independently documented for review by the **RoofStar Guarantee**

Program:

- 1) At least three (3) cut tests for roof areas up to 20,000 sf (200 squares), or one (1) cut test for every 2000 sf (20 squares), whichever is more.
- 2) One (1) cut test for every 3000 sf (30 squares) of roof area that exceeds the first 20,000 sf (200 squares).
- 3) One (1) cut test for each small roof area measuring no more than 200 sf (2 squares).
- 4) Where the roof has been constructed with a structurally sloped *deck*, at least 50% of the required cut tests shall sample roof areas in or near valleys, and areas; samples shall also be taken near roof drains.
- 5) Where the roof has been constructed with a structurally flat *deck*, samples shall be taken near roof drains and in a random pattern across the roof.
- 6) All cut tests for existing SBS-modified membrane roof *systems* shall be performed to *ASTM D7636/D7636M, 11 Standard Practice for Sampling and Analysis of Modified Bitumen Roof Systems*.
- 7) Existing conventionally insulated roof *systems* constructed with Expanded Polystyrene insulation (EPS) may qualify for a **RoofStar Guarantee**, subject to the General Conditions and Limitations below.

1.4.2.3.2 Recovering: General Conditions and Limitations

In addition to the **RoofStar Guarantee Standards** found in this *Manual*, the following additional requirements and conditions apply:

- 1) All wet material identified by either the independent moisture detection survey or through cut tests shall be
 - 1) specified for removal.
 - 2) removed in the course of construction.
- 2) The existing membrane on a *Conventionally Insulated System* must be cut through
 - 1) in a grid pattern measuring no larger than 6m x 6m (approximately 20' x 20').
 - 2) around the perimeter of the roof area, no more than 0.2 m (8") from the edge.
- 3) A grid-cut field membrane must be overlaid with a mechanically attached insulation overlay board acceptable to the **RoofStar Guarantee Program**; notwithstanding this requirement, only non-organic and moisture-resistant overlay boards may be used in the *Project*.
- 4) When Expanded Polystyrene insulation (EPS) is present in an existing *roof system* the existing membrane must be overlaid with at least one layer of 50 mm (2") mineral wool or polyisocyanurate insulation, in combination with a RoofStar-accepted insulation overlay board (as required).
- 5) New membranes must be properly secured to the underlying roof assembly.
- 6) Only new strip-in flashings for roof penetrations are acceptable for a **RoofStar Guarantee**; existing flashings are not permitted.
- 7) Only new roof drains are acceptable for a **RoofStar Guarantee**, and under no circumstances shall existing roof drains be reused.
- 8) Only new *linear metal flashings* are acceptable for installation at perimeters or at membrane terminations, and under no circumstances shall existing *linear metal flashings* be reused.

1.4.2.4 Tie-ins and Additions to Existing Roofing

- 1) Where a new roof adjoins and ties into an existing roof, the two areas must be isolated and separated by a curb joint securely attached to the structure and waterproofed in keeping with the requirements in **2.5 Control Joints** and **Part 10 PERIMETERS and WALLS**.
- 2) If *Project* conditions do not allow for a curb joint, the *Design Authority* must obtain a written Variance from the *Guarantor* that permits the elimination of curb joints. Application for a Variance must include design specifications and construction details showing a positive water cut-off that fully isolates the existing roof

from the new roof. In the absence of a curb joint, the new roof *system* must be easily distinguishable from the existing *roof system*.

1.4.3 Hot Works: Contractor Requirements

- 1) The *Contractor* must maintain the requirements of the RCABC Hot Work Program. This includes the following, without limitation:
 - 1) **Insurance Coverage** – limits carried on the *Contractor's* policy must equal or exceed the minimum requirements set by RCABC, and coverage must be unhindered by warranties that limit or exclude coverage when Hot Work is required.
 - 2) **Education and training** – workers who perform hot work must be trained by the *Contractor* and kept current with acceptable methods.
 - 3) **British Columbia Fire Code** – a Fire Safety Plan, preventative methods or alternative work procedures, fire watches, and the use and placement of equipment at the *Project* site must comply with the *British Columbia Fire Code* requirements for Hot Work.
 - 4) **Fire Safety Plan** – the *Contractor* must assess the hazards to property and persons and produce a written Fire Safety Plan prior to the start of work. The Fire Safety Plan must be kept on the *Project* site and must be kept current until the *Project* is completed.
 - 5) **RoofStar Guarantee Standards** – the *Contractor* must adhere to the **RoofStar Guarantee Standards** at each juncture where the interface of different membranes applications constitutes part of the Fire Safety Plan.
 - 6) **Fire Watch** – the *Contractor* must, as part of the Fire Safety Plan, conduct a fire watch
 - 1) that complies with the *British Columbia Fire Code*.
 - 2) assigned to competent, trained personnel using suitable equipment including the use of a hand-held infrared thermometer.
 - 3) documented in a written fire watch log
 - 7) **Hot Work Notification** – notify the *Project* authority or the AHJ, as and when required, that Hot Works will be performed.

1.5 Workmanship

While integrity and functionality of a new roof or waterproofed *deck* is the foundation of a **RoofStar Guarantee**, it is no less important to ensure that the end finished *Project* exhibits excellent workmanship. Therefore, the following Standards apply:

- 1) The *Contractor* must take reasonable measures to protect the *Project* from damage by the weather, during and at the completion of construction. Open penetrations and flashings must be temporarily sealed off from the weather, even when other trades are responsible to make a permanent seal or install overlapping materials. See also **4.1 General**.

1.5.1 Contractor Qualifications

- 1) Supervision and installation of a **RoofStar-guaranteed Waterproofing System** may be conducted only by established employees of the *Contractor*, and every *Project* must be supervised by a Journey person employee who holds a valid ticket. In keeping with RCABC Membership policy, a Journey person may supervise a maximum of three (3) apprentices and/or three (3) labourers (ref. RCABC Policy A-248, Rev. 5 April 2019).

1.6 RoofStar Guarantee: Coverage and Limitations

A **RoofStar Guarantee** is available for almost any roof design, provided it is designed and built to the Standards in this *Manual*. That said, there are limitations and conditions. They are listed on the *Guarantee* certificate, and include (without limitation) the following (as they are applicable to the type of *Project*):

- 1) The **RoofStar Guarantee** covers leaks resulting from new materials purchased, supplied and installed by the *Contractor*. All new materials incorporated into a *Project* intended to qualify for a **RoofStar Guarantee** must be expressly Accepted by the RGC and listed in the **Roofing Practices Manual**. Accepted Materials include (without limitation)

- 1) *Primary* and *Secondary Materials*.
- 2) penetration flashings and drains.
- 3) roof-related linear metal flashings.

All materials or products supplied by anyone other than an Associate Member, or which are installed by someone other than the *Contractor*, will be excluded from coverage under the *Guarantee*, and may void the *Guarantee* entirely.

- 2) Notwithstanding the definition of a *Waterproofing* or *Water-shedding System*, the **RoofStar Guarantee** does not cover the quality, installation or performance of the *supporting deck*.
- 3) The **RoofStar Guarantee** (subject to the limitations described herein or stated on the *Guarantee* certificate) is a guarantee against leaks only, caused only by a failure of new materials installed by the *Contractor*, or resulting from the *Contractor's* installation of new materials.

The term "new materials" includes *Primary* and *Secondary Materials*, *linear metal flashings*, and both penetration flashings and roof drains that have been expressly accepted for use on a *Project* designed and constructed to qualify for a **RoofStar Guarantee**. Only materials listed in the Accepted Materials Division of the **Roofing Practices Manual** qualify for a **RoofStar Guarantee**.

The re-use of any existing material on a *Project* may void the *Guarantee*.

- 4) Notwithstanding any of the *Guarantee* requirements in this *Manual*, a **RoofStar Guarantee** will not cover
 - 1) leaks resulting from
 - 1) improper design.
 - 2) overloading.
 - 3) water entry from other building components (*walls*, skylights, etc.).
 - 4) the failure of a drain or flashing supplied or installed by anyone other than the *Contractor*.
 - 5) neglected maintenance of the *Project*.
 - 6) building air leakage.
 - 7) modifications to the *Project* made by anyone other than the *Contractor*.
 - 8) changes in building use or occupancy.
 - 2) drain leaders, which are not considered part of the roof *system*.
 - 3) the costs to remove and reinstall irrigation or other services (including, without limitation, electrical and gas services).
 - 4) replacement (new for old) of any *Overburden*.
 - 5) damage or leaks caused by the roots of invasive plant species (for example, certain varieties of bamboo or willow), regardless of measures taken to protect the membrane.
 - 6) a sacrificial third ply or a coating, used as a walkway or warning zone, as it is not considered part of the roof *system*
- 5) *Overburdens* may be installed on a *Conventionally Insulated Waterproofing System* or *Protected ("inverted") Membrane Roof Assembly*, but not all designs are suitable for any type, size or depth of *Overburden* (see **Part 14 THE ROOF as a PLATFORM** in *Waterproofing Systems* standards). **The RGC recommends that a roof supporting *Overburden* be designed and constructed as a *Protected Membrane Roof Assembly*.** The **RoofStar Guarantee** may be void if a roof is designed and constructed with *Overburden* that exceeds the capabilities of a *Conventionally Insulated Waterproofing System*.
- 6) Only a fully adhered membrane may be used in a *Protected ("inverted") Membrane Roof Assembly*.
- 7) **Integrity Scans:** An Integrity Scan
 - 1) must be performed by an RGC-recognized service provider.

- 2) is required on all *Waterproofing Systems*, to ensure the waterproofing is leak and damage-free, when *Overburdens*, amenities or equipment are or will be installed on the completed *Waterproofing System* by
 1. anyone other than the *Contractor*.
 2. the *Contractor* but only when the *Overburdens*, amenities or equipment exceed 150 mm (6") in depth.
- 3) is not required when the *Contractor* installs *Overburden*, amenities or equipment equal to or less than 150 mm (6") in depth.

See **Figure 1.1** for further reference.

- 7) **Electronic Leak Detection** is mandatory for grade-level *Waterproofing Systems*, but optional for *Waterproofing Systems* on roofs.
- 8) **Pre-curbs and Concrete Features**
 - 1) When concrete *walls* or structures are constructed without a pre-curb, all concrete surfaces must be fully and continuously enveloped with the primary roof membrane.
 - 2) While the application of non-penetrating bonded tiling or other architectural finishes to the waterproofing membrane is acceptable for a **RoofStar Guarantee**, and is subject to approval by the membrane manufacturer, the removal, reinstallation or replacement of any bonded finish, in order to investigate and repair leaks under the terms of the *Guarantee*, is the responsibility of others.
- 9) **Modifications during the Guarantee Term**
 - 1) RGC must be notified in writing of any modifications or repairs to the RoofStar-guaranteed *Project*.
 - 2) The owner must ensure that any modifications or repair work done on the *Project* during the guarantee period is performed to **RoofStar Guarantee Standards** by a *Contractor* and is inspected by a RoofStar-accepted observation firm.

Figure 1.1

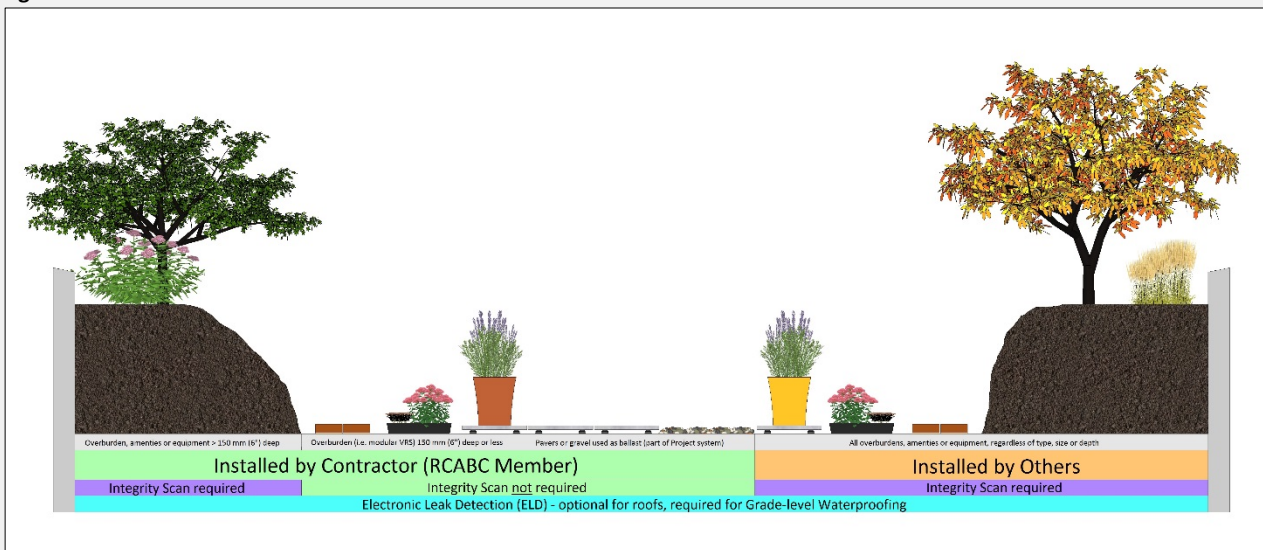

- 10) **Maintenance:** the building Owner must ensure that the *Project* and its components are properly maintained. Debris in drains, caulking on or around metal flashings, and wind scouring of gravel are considered maintenance issues.
- 11) **Removal and Reinstallation of Overburdens:** in order to investigate and repair a leak, the **RoofStar Guarantee Program** must be allowed to remove *Overburdens*, to expose the membrane. The **RoofStar Guarantee** pays for the removal and reinstallation of accessible Overburdens only, when they are installed by the *Contractor*, regardless of the *Project* design. The cost to remove, care for and reinstall any *Overburden*

that exceeds these limits or conditions, which is *inaccessible* or which was supplied or installed by others, will be borne by the Owner.

- 1) **Maximum coverage area:** limited to one physically defined *Project* area (no maximum size).
 - 2) The **RoofStar Guarantee** pays for removal and reinstallation of
 1. *Extensive vegetated roof systems*, provided they are comprised of trays or other recognized modular methods and are less than 150 mm (6") in depth, exclusive of the plants.
 2. other accessible coverings, provided they are unitized (for example, pavers on pedestals) and do not exceed 1 M2 or 90 Kg (200 lb.) per unit.
 3. gravel ballast and its associated drainage or protection material components, provided the ballast is less than 150 mm (6") deep.
 - 1) structures, furnishings or planters provided each item, or any single component of each item, is easily detachable, does not require a specialty trade, and is no heavier than 90 Kg (200 lb).
-

2 SUPPORTING STRUCTURES: Decks and Walls

2.1 General

2.1.1 Definitions

Refer to the [Glossary](#) for further definitions of key terms used in this *Manual*.

Supporting deck (“deck”)

means the structural surface to which the *Waterproofing* or *Water-shedding System* is applied (adapted from *ASTM D1079-18 Standard Terminology Relating to Roofing and Waterproofing*).

Deck overlay

means a panel material secured to the *Supporting Deck* in order to render the *deck* surface continuous or suitable for the installation of roofing materials.

Wall

means a structural or non-structural element in a building that vertically separates space. *Walls* may separate the outside environment from the interior conditioned space of a building, or they may separate one or more interior spaces from each other (adapted from *ASTM E631-15 Standard Terminology of Building Constructions*).

Wall overlay

means a panel material secured to the surface of a *wall*, to render it suitable for the installation of roofing or *wall* cladding materials.

2.1.2 Design

- 1) The *British Columbia Building Code*, or the building code having jurisdiction, prevails in all cases except where it is exceeded by the **RoofStar Guarantee Standards** published in this *Manual*.
- 2) Notwithstanding the **RoofStar Guarantee Standards** published in this *Manual*, the **RoofStar Guarantee** does not extend coverage to the *supporting deck* or to its securement, which is the responsibility of the *Design Authority* and the building contractor.
- 3) Prior to the application of the *roof system*, the *supporting deck* and other surfaces receiving membranes must be smooth, straight, clean and free of
 - 1) moisture.
 - 2) frost.
 - 3) dust and debris.
 - 4) contaminants.
 - 5) objectionable surface treatments.
 - 6) release oils.
 - 7) laitance.

If surface drying is required prior to roofing, use blown air to facilitate this.

- 4) *Walls, parapets, curbs, blocking and penetrations* should be constructed or placed prior to the commencement of roofing work. This work is provided by other trades.
- 5) The *supporting deck* structure should be dimensionally stable and capable of accommodating *roof system* component movement.

2.2 Roof Slope

2.2.1 General

- 1) The **RoofStar Guarantee Program** classifies roofs according to their function – waterproofing or water-shedding. Within each classification, slope is defined as follows:
 - 1) **Flat** means a roof with a slope less than 1:6 (2” in 12”, or 9 degrees).

- 2) **Low Slope** means a roof with a slope from 1:6 (2" in 12", or 9 degrees) up to but less than 1:3 (4" in 12", or 18 degrees).
- 3) **Common Slope** means a roof with a slope 1:3 (4" in 12", or 18 degrees) up to and including 1:1 (12" in 12", or 45 degrees).
- 4) **Steep Slope** means a roof with a slope greater than 1:1 (12" in 12", or 45 degrees) up to and including 21:12 (21" in 12", or 84 degrees).
- 5) **Extreme Slope** means a roof with a slope greater than 21:12 (21" in 12", or 84 degrees).

See **Figure 2.1** for an illustrated guide to the above definitions.

Figure 2.1

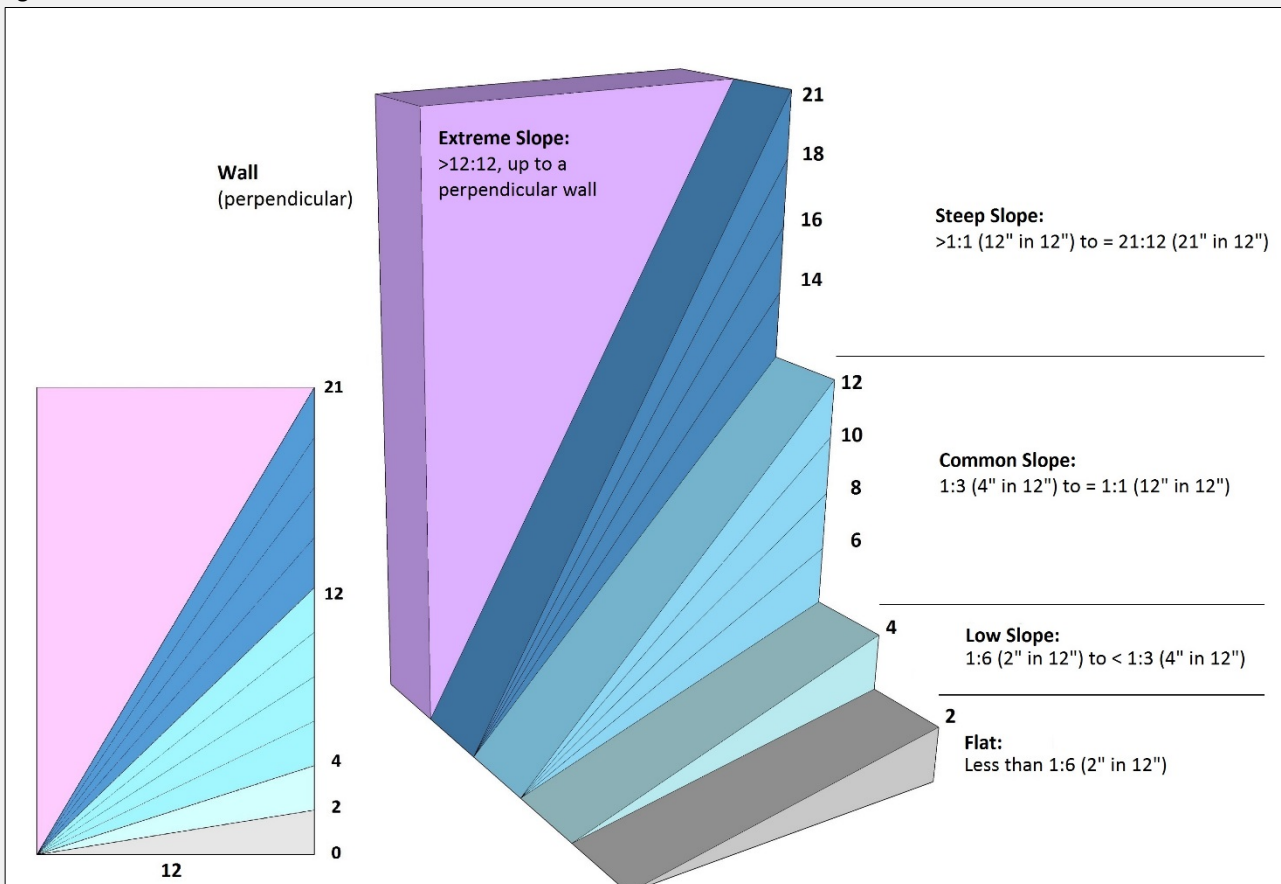

- 2) While good drainage is desirable but not always perfectly achievable, and waterproofing roof systems generally are not affected by standing water, each *Project* design should incorporate sufficient slope to move water off the roof surface. Sufficient slope is attained when (subject to conditions that permit evaporation) no standing water remains on the roof surface, after a reasonable interval following a rainfall. Local climate conditions may necessitate design slopes higher than the minimums published in this *Manual*. See **2.2.2 New Construction** and **2.2.3 Replacement Roofing** for minimum requirements.
- 3) Roof slope can be achieved either by designing the roof structure with sloped *decks*, or by introducing slope with tapered board insulation.
- 4) Deflection and settlement may interfere with roof drainage. Therefore, the *Design Authority* must take into consideration the anticipated deflection of the structure when designing the roof for proper drainage.
- 5) Drainage is best achieved (in descending order of best practices) with
 - 1) four-way slope to drain.
 - 2) two-way slope to drain, in combination with crickets between drains.

- 3) slope to a common valley, or with gutters.
- 4) **positive sloping valleys to drains (highly recommended).**
- 6) **Curbs that span 1800 mm (6') or more across the drainage plane should be designed with a cricket to divert water around the curb.**
- 7) Drain sumps, designed to isolate collected water for the drain, need not be sloped. **The use of drain sumps is highly recommended.** See also **11.1.2.2 (9) All Projects.**

2.2.2 New Construction

- 1) All new construction roofs that qualify for a **RoofStar Guarantee** must be designed and built with a slope of no less than 2% (1/4" in 12"), measured on the primary sloped planes of the roof.

2.2.3 Replacement Roofing

- 1) Replacement roof *systems* may qualify for a 5 or 10-Year **RoofStar Guarantee** without correcting poor drainage, though **the elimination of ponding (standing water) is strongly recommended.**
- 2) **RoofStar 15-Year Guarantee:** replacement roofs must
 - 1) be sloped at least 2% (1/4" in 12"), measured on the primary sloped planes of the roof, in order to qualify for a **RoofStar 15-Year Guarantee.**
 - 2) incorporate crickets at *curbs* and sleepers that impede drainage or are wider or longer than 1200 mm (48").

See also **Part 7 INSULATION.**

2.3 Supporting Deck Types

2.3.1 Steel

Steel roof *decks* are constructed of light gauge (usually 22, 20, or 18 gauge) cold-rolled steel sections (panels) that are usually galvanized. In cross-section the panels are ribbed, with the ribs usually spaced at 150 mm (6") O.C. The ribs provide the strength and rigidity of the panels. Steel *decks* are generally supported by open-web steel joist framing and are welded or mechanically-fastened to the framework.

For more information about steel *decks*, see [Roof Decks](#) in **Division B: Essential Elements.**

- 1) Steel *deck* panels must be installed to provide a smooth uniform surface for roofing.
- 2) **A thermal barrier may be required to conform to building code or fire insurance-rated assemblies, when the roof assembly is insulated (usually when the insulation is classified as combustible).**
- 3) Uninsulated *systems* require a *deck* overlay for the membrane. A RoofStar-accepted moisture resistant fibreglass-faced, silicon treated gypsum core board may serve both as a thermal barrier and as a level surface. For more about this, see **5.3.2 Steel Decks.**

2.3.2 Concrete

Concrete roof *decks* to which a roofing *system* is applied include the following types:

- Cast-in-place.
- Pre-cast panels.
- Pre-stressed panels.
- Lightweight.

Not all membrane assemblies are suitable for application on every type of concrete *deck*, and therefore the *Design Authority* is strongly urged to consider potential *deck* deflection when designing the assembly.

For more information about concrete *decks*, see [Roof Decks](#) in **Division B: Essential Elements.**

- 1) It is not permissible to adhere roof membranes to freshly poured concrete supporting *deck* structures, within the first 28 days after pouring, unless expressly instructed in writing by the building envelope engineer. Adhered means adhered by means of an adhesive, hot bitumen or heat.
- 2) *Deck* preparation by others:

- 1) Remove all ridges and bumps, and repair cracks.
- 2) Feather with grout all weld plates and elevation differences.
- 3) Pre-cast *decks* joints should be “taped” or stripped-in with a membrane ply.

2.3.3 Wood

Wood is a common roof *deck* construction material that has been used for many years because of its economy, ease of fabrication, lighter construction, and ready availability. Acceptable wood roof *decks* may include (without limitation)

- wood board (dimensional lumber, ship-lapped planking, etc.).
- plywood.
- non-veneered wood *decks* (oriented strand board, waferboard, etc.).
- laminated timber.

For more information about wood *decks*, see [Roof Decks](#) in **Division B: Essential Elements**.

The following criteria apply to all types of wood *decks*:

- 1) Notwithstanding minimum wood *deck* thickness requirements published in the Building Code having jurisdiction, when a roof must be designed to resist *Specified Wind Loads*, plywood or non-veneered panels (such as O.S.B. or wafer board) used as a roof *deck* must be at least 12.7 mm (1/2”) thick, unless exceeded by the *deck* thickness specified in a *Tested Assembly* (often 19 mm (3/4”), an *Assembly with Proven Past Performance*, or a roof assembly with custom-engineered securement.
- 2) Wood *decks* shall be secured to other supporting structural elements of the building in keeping with the published requirements of the Building Code having jurisdiction.
- 3) Differential edge movements or deflection exceeding 1/360 of the span must be prevented by any of the following options:
 - 1) construct the *deck* with tongue-and-groove plywood and support the non-grooved edges with joists or solid blocking.
 - 2) support butt joints with solid blocking under non-supported edges.
- 4) All wood *decks* must be affixed to the supporting framing or structure with corrosion-resistant
 - 1) wood screws.
 - 2) spiral nails.
 - 3) ring shank nails.

The structural suitability of the fastener is the responsibility of the *Design Authority*.

- 5) All wood *decks* with knots or cracks must
 - 1) have metal affixed over them before the *deck* can be accepted for roofing (this work should be done by others).
 - 2) be overlaid with a layer of knot-free plywood at least 12.7 mm (1/2”) thick.
- 6) All types of wood *decks* should be roofed promptly after installation.
- 7) When a plywood *deck* is intended to support a *Protected Membrane Roof System* and a vegetated roof system, the plywood should be marine-grade T&G material at least 19 mm (3/4”) thick, depending up on the anticipated live and dead loads of the roof systems. The *Design Authority* is responsible to calculate these loads and design suitable approaches to mitigate deflection.
- 8) All mass timber or wood board *decks* must be covered with a properly secured, suitable overlay to protect membranes from wood sap or *deck* surface irregularities and protruding fasteners. Plywood and non-veneered panel *decks* are exempted from this requirement.

2.3.3.1 Plywood

- 1) Plywood roof *decks* consist of exterior type plywood mechanically fastened to the roof framing. The plywood panels should conform to *CSA 0121, “Douglas Fir Plywood”, CSA 0151, “Canadian Softwood Plywood”, or CSA 0153, “Poplar Plywood”*, following requirements published in the Building Code having jurisdiction.

- 2) Plywood roof sheathing should be installed in a staggered pattern with the surface grain at right angles to the roof framing.

2.3.3.2 Laminated Timber

Laminated timber *decks* are typically comprised of crossing layers of dimensional solid wood material, laminated to form a thick, dimensionally stable slab strong enough to support significant structural loads.

2.3.3.3 Non-veneered Panels

See **Part 9 FIELD MEMBRANES** for application standards and limitations.

2.3.3.4 Wood Boards

- 1) Wood board *decks* include tongue-and-groove, ship-lapped, or splined boards or planks. These typically range in thickness from 19 mm to 89 mm (nominal 1" to 4").
- 2) Wood board *decks* may also include Mill *decks*, also called Nail-Laminated Timber *decks*. These are constructed with a single layer of dimensional boards (dimensions can vary), placed on edge and spiked together to form a "mill deck". The thickness of the boards is determined by the anticipated loads and spacing of roof joists or trusses (consult the local or provincial Building Code having jurisdiction).
- 3) Wood board *decks* should be of sound seasoned lumber, properly secured to the supporting structure.

2.4 Expansion Joints

See [Construction Details](#) and **10.3.6 Expansion and Control Joints** for membrane application.

Roof expansion joints, or movement joints, are designed to safely absorb thermal expansion and contraction of materials, or to absorb vibration. They also allow for movement caused by settlement and earthquakes.

- 1) Structural expansion joints should be considered wherever
 - 1) the type of *deck* changes.
 - 2) additions connect to existing buildings.
 - 3) separate wings of a building join (e.g. "L" or "T" configurations).
 - 4) interior heating conditions change.
 - 5) differential movement may occur (e.g. parapet detail where the *deck* is not supported by the *wall*).
- 2) The location of expansion joints must be clearly indicated on the drawings, drawn in detail, and included in the specifications.
- 3) The construction of structural expansion joints is the responsibility of others and must be in place before the *Contractor* accepts the *deck* for roofing.
- 4) Expansion joints constructed as a raised divider must have a sloped top surface and must extend in height above the *Finished Waterproofing System* no less than 200 mm (8"). The minimum height of the Expansion Joint may be reduced to 125 mm (5") if the primary roof membrane flashing is fully supported and sealed over the top.

2.5 Control Joints

See [Construction Details](#) and **10.3.6 Expansion and Control Joints** for membrane application.

Control joints (sometimes referred to as roof dividers) are site-built but relatively uncommon for roofs with flexible membranes. They are designed to help control thermal expansion and contraction stresses in the roof *system* where no structural expansion joint has been provided in the building design. *Control joints* may be present on older roofs with built-up roof *systems* and will have to be taken into consideration by the *Design Authority*; in some cases, control joints may be eliminated for replacement roofing. Still, *control joints* may be employed by the Design Authority to control expansion and contraction of any materials in the roof assembly, or for dividing existing roof areas for phased replacement roofing.

- 1) The *Design Authority* is responsible to determine the need for roof dividers and *control joints* and is responsible for their design. *The use of roof dividers and control joints should be evaluated on a product performance basis.*
- 2) *When roof dividers are specified and detailed, they should divide the roof into approximately equal, regular shaped areas. Ideally, roof dividers should be located at the high points of the roof, with drainage away from the divider on both sides, but drainage must not be impeded by the roof divider.*
- 3) The location of roof dividers must be clearly indicated on the drawings, drawn in detail, and included in the specifications. Specifications should clearly indicate responsibility for their construction.
- 4) When roof dividers are already present (during replacement roofing), the dividers must extend at least 100 mm (4") in height above the *Finished Waterproofing System*.

2.6 Walls

2.6.1 General

- 1) *Wall surfaces must be clean, dry and smooth, suitable for the application of roof system materials. When the wall surface is unsuitable to receive waterproofing materials, it must be resurfaced with an RGC-accepted wall overlay. See Part 5 DECK and WALL OVERLAYS for material and application standards.*
- 2) *Sheathing*, defined as a rigid panel material secured directly onto framing, is considered a *wall* surface for the purpose of this Standard.
- 3) *Wall surfaces receiving waterproofing materials must extend vertically beyond the maximum height of waterproofing materials but in any event must extend vertically must be installed at least 200 mm (8") high, above the finished roof surface. For suitable wall surface materials see 2.6.2 below.*
- 4) *Walls and roofs commonly intersect in two ways:*
 - 1) *Directly, where the wall structurally connects to the roof structure, so that both move together.*
 - 2) *Indirectly, where the roof structure and the wall structure are independent of each other, so that the movement of one does not affect the other.* These locations require an expansion joint.
- 5) The *Design Authority* must ensure a continuous connection between the roof system from field to perimeter, in order to control or inhibit the movement of water, air and vapour.

2.6.2 Material

- 1) Concrete surfaces must comply with the requirements set out in **2.1.3**. When concrete surfaces do not comply, concrete walls may be sheathed with any one of the following:
 - 1) 15.9 mm (5/8") thick treated plywood.
 - 2) fibre-mat reinforced cement boards with a minimum thickness of 9.5 mm (3/8").
- 2) Both materials must also conform to *ASTM C1325-04*.
- 3) For framed walls, the following material are acceptable:
 - 1) *Moisture resistant gypsum core boards specifically designed to receive roof membranes with a minimum thickness of 12 mm (1/2"). These panel may be installed horizontally or vertically.*
 - 2) fibre-mat reinforced cement boards with a minimum thickness of 9.5 mm (3/8").
 - 3) *Plywood with a minimum thickness of 12 mm (1/2").*

2.7 Electrical Cables and Boxes

Electrical cables (including conduit) or boxes installed inside, on top of, or beneath a roof assembly expose roofing workers to electrical shock, and may inhibit the installation of some roof systems designed to resist wind uplift. Furthermore, electrical cables on, in or under the roof assembly expose the building and the public to both shock and fire. Hidden electrical wiring and boxed junctions can be extremely difficult to document before work begins, and while some technologies are purportedly accurate in identifying energized circuits before they are damaged, false readings make these technologies less than reliable. During replacement roofing, avoiding damage to electrical circuits from cutters and fasteners is sometimes next to impossible. It is therefore desirable to design buildings with realistic separations between electrical wiring and boxes, and roof assemblies.

For more about this topic, see the reprinted Safety Bulletin issued by the **BC Safety Authority**, republished in the November 10, 2015 [Technical Update](#).

Currently, neither the *Canadian Electrical Code, Part I* nor the *British Columbia Electrical Code* explicitly prohibit, nor explicitly permit, the installation electrical cables and boxes anywhere in close proximity to a roof assembly. The *Design Authority* therefore has the latitude to write restrictions concerning the location of electrical installations, and consequently eliminate shock and fire hazards. To do so, apply the following standards when preparing *Project specifications* to qualify for a **RoofStar Guarantee**.

2.7.1 New Construction

- 1) Electrical cables, raceways or boxes shall not be installed within a roof assembly (**Figure 2.7.1-1**).
- 2) Electrical cables, raceways or boxes shall not be installed on the underside of a roof assembly, unless
 - 1) the supporting *deck* structure equals or exceeds 76 mm (3") in thickness (**Figure 2.7.1-2**), or
 - 2) the cables, raceways or boxes are installed and supported so there is a separation of not less than 38 mm measured between the underside of the roof assembly and the electrical installation (**Figure 2.7.1-3**).
- 3) Notwithstanding either (1) and (2), cables or raceways shall be permitted to pass through a roof assembly for connection to electrical equipment installed on the roof, provided that the passage through the roof is a part of the roof assembly design.
- 4) Electrical cables installed above the roof assembly should be elevated to permit proper support, roof maintenance and future replacement roofing (**Figure 2.7.1-4**)

Figure 2.7.1-1

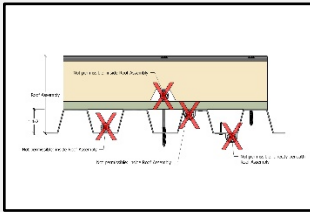

Figure 2.7.1-2

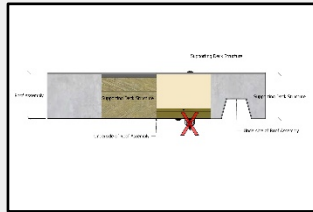

Figure 2.7.1-3

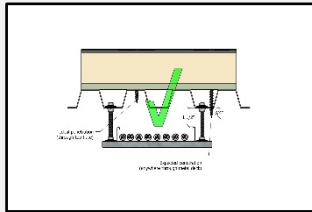
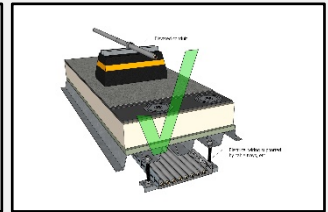

Figure 2.7.1-4



2.7.2 Replacement Roofing

- 1) If existing electrical cables or boxes do not conform to the standards in **2.7.1 New Construction**, the *Design Authority* must consider the attachment of the roof system above the electrical system, and the requirements set out in **Part 3 SECURING the ROOF ASSEMBLY**.
- 2) The *Design Authority* should
 - 1) specify protection of existing electrical cables and boxes (a 5 mm (3/16") steel plate may be used to minimize the possibility of fastener penetration and cutter damage, but it should be understood that protection plates may interfere with mechanical fasteners used to secure the roof system against wind uplift, even for future replacement roofing).
 - 2) provide the building owner with detailed as-built drawings that accurately map the location of electrical cables and boxes.

3 SECURING the ROOF ASSEMBLY



Click on the gif above to see the **full high-definition video**, which illustrates why roof *system* attachment standards matter (**NOTE**: the *system* shown in the video represents a mechanically fastened EPDM roof, constructed to **RoofStar Guarantee Standards**. The membrane "flutter" in wind is normal for this type of roof *system*).

3.1 General

3.1.1 Definitions

Refer to the [Glossary](#) for further definitions of key terms used in this *Manual*.

CSA Standard ("the Standard") means the *CSA Standard A123.21 Standard test method for the dynamic wind uplift resistance of membrane-roofing systems* (latest edition).

Ballast, when used in this *Manual*, refers to a material used for securing the *roof system*. When gravel or pavers are used in this way, they are considered part of the *roof system*.

Overburden is any material, structure or item of equipment that is placed on top of the completed roof. Gravel or pavers are considered to be overburden when they do not serve to secure the *roof system*. See also **14.1.1 Definitions**.

3.1.2 Design

Wind that compromises a membrane roof *Waterproofing System* often results in leaks, sometimes with catastrophic consequences. Therefore, the *Design Authority* must pay attention to the design of the roof and its performance under windy conditions.

Conventionally Insulated Roof Systems are governed by standards adopted in this *Manual* from the *National Building Code of Canada* (NBCC) and the *British Columbia Building Code*. The *British Columbia Building Code* requires the proper calculation of *Specified Wind Loads*, and securement of the roof components using a *Tested Assembly* or, in the alternative, either a *Assembly with Proven Past Performance* or an assembly that is otherwise engineered to resist the *Specified Wind Loads* of a roof. **RoofStar Guarantee Standards** require these same measures for new or fully replaced *Conventionally Insulated Systems*, in order to ensure the *roof system* is not compromised by wind that could, as a consequence, cause leaks. In addition, this Part sets out the requirements for

- 1) material substitution (applicable to *Tested Assemblies* or *Assemblies with Proven Past Performance*).
- 2) fastener and adhesive application (minimum numbers and spacing).
- 3) roofs installed with overburden, *Protected Membrane Roof Systems*, and roofs where only part of the *system* must be replaced.

Protected and *Modified Protected Membrane Roof Systems*, and uninsulated roof systems (with or without ballast) must be designed to resist the calculated *Specified Wind Loads*, but their securement cannot be determined with the use of a *Tested Assembly* report, which pertains only to *Conventionally Insulated Systems*. Rather, the *Design Authority* must refer to other resources to determine how to secure the roof against negative wind pressures. Some of those resources may be found in this Part.

Where a **RoofStar 15-year (Waterproofing Roof) Guarantee** is specified, and enhanced *roof system* securement is required by the membrane manufacturer in order to meet their *system* warranty requirements (enhanced securement may exceed the securement required in a *Tested Assembly*, an *Assembly with Proven Past Performance*

or a custom-engineered securement), the higher securement requirements must be complied with in the design and construction of the *Project*. See also **1.3.1 RoofStar 15-Year Guarantee** for further general requirements.

The Standards, Guiding Principles and Recommendations in this sub-section are illustrated in the decision tree/flow chart shown as **Figure 3.3**, and must be read in conjunction with **3.3 Application**.

3.1.2.1 General

- 1) The *Design Authority* is responsible for the proper calculation of *Specified Wind Loads* for a roof *Waterproofing System*, regardless of its design, and must use the [Wind-RCI online wind calculator](#) or, in the alternative, another method that is its equal or superior. This includes roofs that support an overburden, including *Vegetated Roof Systems*. When the geometry of a building exceeds the capabilities of the Wind-RCI calculator, the *Design Authority* must calculate wind loads in accordance with the *British Columbia Building Code, Division B, Part 4, 4.1.7 Wind Loads*, and in consultation with other Parts and Sections of the *British Columbia Building Code* as they pertain to the determination of *Specified Wind Loads*. Acceptance of a roof for a **RoofStar Guarantee** is predicated on the assumption that the *Design Authority* has performed Due Diligence with respect to *Specified Wind Loads* and the attachment methods for the roof assembly.
- 2) All roof *Waterproofing Systems* shall consist of the following three zones, illustrated in **Figure 3.1**.
 - 1) **Field (F)** – the interior of the roof bounded by the *Edge* and the *Corners*.
 - 2) **Edge (E)** – defined as 10% of the building width or 40% of the building height, whichever is less. In no case will perimeter zone be less than 2.0 m (7').
 - 3) **Corner (C)** – part of the perimeter but not less than 2.0 m x 2.0 m (7' x7') in size. The *Corner* area is defined by the *Edge* in both directions at the corners.

Figure 3.1

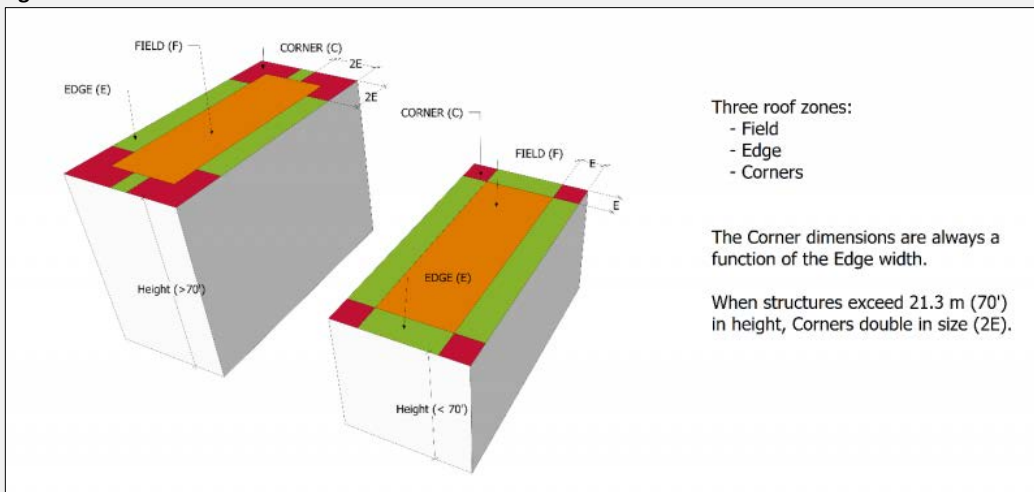

- 3) A *Conventionally Insulated System*, and a *Modified Protected Membrane Roof System*, constructed on a bare roof *deck* (new construction and replacement roofing) must be secured using
 - 1) a *Tested Assembly* (see **3.3.1.1 Tested Assemblies**).
 - 2) an *Assembly with Proven Past Performance* (see **3.3.1.2 Roof Assemblies with Proven Past Performance**).
 - 3) engineered methods and patterns (see **3.3.1.3**; also refer to the *British Columbia Building Code, Division B, Part 4 and Part 5* together with the *ANSI/SPRI WD-1* methodology referenced in the *British Columbia Building Code, Notes to Part 5 – Environmental Separation, A-5.2.2.2.(4)*).
- 4) The wind uplift resistance capabilities of the selected *roof system* must equal or exceed the *Specified Wind Loads*.

- 5) A roof consisting of a single elevation, divided into smaller roof areas by means of control joints (roof dividers) or expansion joints, shall be considered one roof area for the purpose of calculating the *Specified Wind Loads*.
- 6) When a building is designed with multiple roof levels,
 - 1) the *Specified Wind Load* for each roof area must be calculated separately, unless the roofs are adjacent each other and the elevation difference between roof areas is less than 1.52 m (5').
 - 2) each roof area must be designed with *Edge (E)* zones on all sides, and *Corner (C)* zones at each outside and inside corner, irrespective of the elevation difference between the roofs.

Figure 3.2

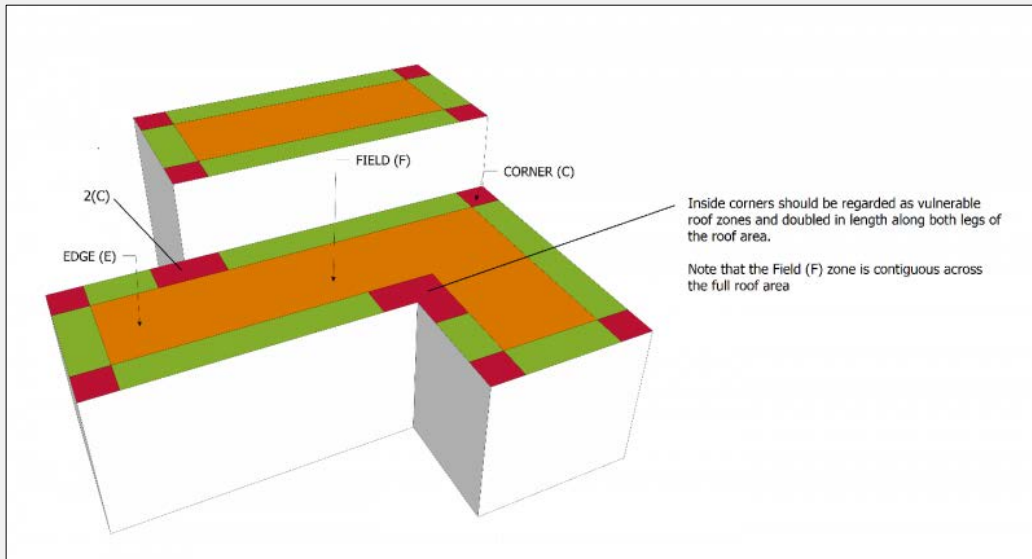

- 7) When a roof includes an inside corner, the *Corner* zones must extend along each adjacent side of the roof a distance equal in dimensions to outside corners (**Figure 3.2**).
- 8) When a roof area intersects the corner of a *wall*, the *Edge* zone on either side of the *wall* corner must be treated as a roof *Corner* (2 x C) (**Figure 3.2**).
- 9) When an existing roof *system* is specified for partial replacement, the *Design Authority* must
 - 1) calculate the *Specified Wind Loads* for the roof.
 - 2) determine whether or not securement of the remaining roof components (left in situ) is sufficient to resist the *Specified Wind Loads*.
 - 3) determine a suitable method of securement or have the *system* of securement engineered.
 - 4) calculate and design securement for any overburden.

See **Figure 3.3** for an illustration of this process.

See also **1.4.2 Replacement Roofing**, **3.3.3 Partial Roof Replacements** and **Part 14 THE ROOF as a PLATFORM**.

- 10) When specifying securement for a partial roof replacement, mechanical fastening, when practicable, is the recommended method for securing new materials to an existing roof system. All other methods of securement must be designed and specified by the *Design Authority*.
- 11) Roof systems should be designed in conjunction with the electrical systems for the building, in order to avoid unnecessary interference with roof system securement. Placement of cables and boxes in designated trays, suspended at least 38 mm (1 1/2") below a penetrable supporting deck, is strongly recommended in order to avoid contact with roofing fasteners; fastener penetration may result in shock or fire hazard. Steel plates should not be used to shield conduit and boxes on top of or immediately beneath a penetrable deck, because

the plates will interfere with fastener placement and proper securement of the roof system. See also 2.7 Electrical Cables and Boxes.

- 12) Securement of *Water-shedding Systems* shall be made in accordance with the requirements set out elsewhere in this *Manual*.

Figure 3.3

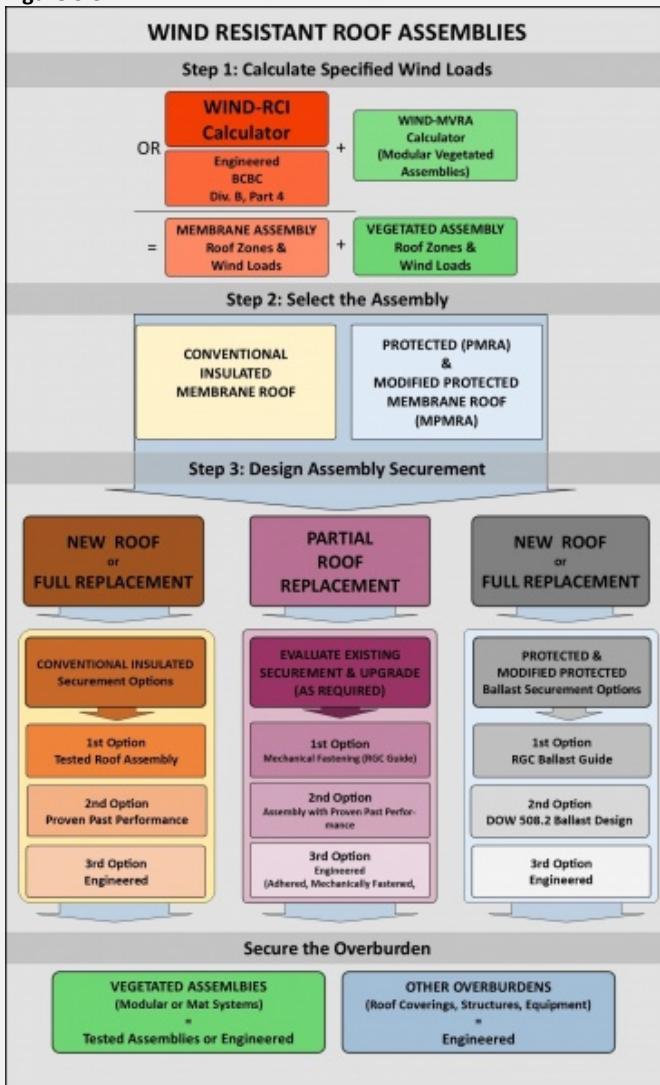

3.1.2.2 Roofs with Ballast or Overburdens

NOTE: the reader must consult the Design and Application requirements in **12.1 Protected and Modified Protected Membrane Roof Systems**, together with requirements in **Part 14 THE ROOF as a PLATFORM** (with respect to *Vegetated Roof Systems*).

- 1) When vegetation and its growing media is intended as either ballast or *Overburden* on any membrane roof assembly, the *Design Authority* must, in addition to calculating the *Specified Wind Loads* for the roof assembly, determine the *Specified Wind Loads* for the *Vegetated Roof Systems (VRS)*, and the dimensions of the roof zones, using the [WIND-MVRA](#) online calculator tool or, in the alternative, another method that is its equal or superior. Note that this online resource applies only to buildings described on the Wind-RCI website at "low rise" and of moderate height (limited to 20 m or 65 feet) with a *Waterproofing System* roof. Designing appropriate securement of a *VRS* on roofs taller than 20 m (65') or with slopes greater than 2:12 must be undertaken by a licensed design professional using current wind engineering practices and must be

acceptable to the *Authority Having Jurisdiction* (AHJ). Securement methods and details of a *VRS*, regardless of building height and roof slope, are the responsibility of the *Design Authority*.

- 2) *VRSs* that are not modular, and *VRSs* on buildings that do not conform to the parameter of the Wind-VRA calculator, must be engineered to resist *Specified Wind Loads*.
- 3) Ballasted loose-laid membrane roof systems, and systems designed as *Protected* or *Modified Protected Membrane Roof Systems* that utilize gravel ballast, must be designed for adequate securement by
 - 1) calculating the *Specified Wind Loads* for the roof assembly.
 - 2) selecting the appropriate ballast using
 - 1) the RGC ballast guide (see **3.3.2 Ballasted Roof Systems**, and **12.1 Protected and Modified Protected Membrane Roof Systems**).
 - 2) the [Dupont Tech Solutions 508.2 Ballast Design Guide for PMR Systems](#).
 - 3) a custom-engineered system.
- 4) When pavers are selected as ballast for a *Protected* or *Modified Protected Membrane Roof System*, the *Design Authority* is responsible for determining the support and placement of pavers to resist wind uplift.
- 5) *Modified Protected Membrane Roof Systems* must be designed for wind resistance following the requirements for *Modified Protected Membrane Roof Systems* and *Conventionally Insulated Systems*.
- 6) The *Design Authority* is responsible for determining the proper securement of any overburden intended for placement on top of the roof platform. For design, material and installation standards pertaining to roofs as platforms, refer in this *Manual* to **Part 14 The ROOF as a PLATFORM**.

3.2 Materials

3.2.1 Material Substitutions in Tested Assemblies

- 1) When a manufacturer's *Tested Assembly* incorporates materials (and listed alternates) that are not part of the **RoofStar Guarantee Program**, the *Design Authority* must identify appropriate substitutions for those materials from the list of [RoofStar-accepted Materials](#) and consult the manufacturer concerning compatibility with the *Tested Assembly*.

3.2.2 Gravel Ballast

- 1) Gravel ballast used to secure a *Protected* or *Modified Protected Membrane Roof System* must be clean, washed, round or crushed stone, falling within the following gradations:
 - 1) 35 mm (1 ½") - 100 % Passing
 - 2) 25 mm (1") 70 - 100 % Passing
 - 3) 20 mm (¾") 5 - 20 % Passing
 - 4) 12.7 mm (½") 0 - 6 % Passing
 - 5) 5 mm (3/16") 0 - 2 % Passing

Any variance to the above must be accepted in writing by the owner or the owner's representative and submitted to the **RoofStar Guarantee Program** as part of the *Guarantee* record.

3.2.2 Fasteners and Adhesives

The following minimum standards apply to any *roof system*, regardless of requirements published elsewhere.

- 1) Fasteners and adhesives must be capable of securing the *roof system* components for *Specified Wind Loads*.
- 2) *The Design Authority* should specify the correct type of fastener, keeping in mind
 - 1) pull-out strength.
 - 2) corrosion resistance (contributing factors to fastener corrosion may include dissimilar metal contact, excessive building humidity, corrosive chemicals within components of the *roof system*, or corrosive elements provided within the building envelope etc.).
- 3) Unless otherwise listed in the system components of a *Tested Assembly*, self-drilling screws with recessed heads must be used in combination with plates as follows:

Table 3.1 Minimum Fastener and Plate Requirements

Material	Fastener Size	Plate
Deck overlays	#12	73 mm (2-7/8") Hexagonal, 76 mm (3") Round or Square
Insulation	#12	73 mm (2-7/8") Hexagonal, 76 mm (3") Round or Square
Insulation Overlays	#12	73 mm (2-7/8") Hexagonal, 76 mm (3") Round or Square
Membranes	#14	Proprietary

- 4) Adhesives listed in a selected *Tested Assembly* must be used to secure applicable layers within the *roof system*. Adhesives may be substituted only with products listed in the *Tested Assembly* report.
- 5) In the absence of a *Tested Assembly*, or for adhered and partially adhered *Assemblies with Proven Past Performance*, adhesives must be acceptable to the manufacturers of the roof assembly components.
- 6) Bitumen used as a hot-applied adhesive must be Type 3 or SEBS.

3.3 Application

(NOTE: this Section is critical for both the *Design Authority* and the *Contractor*)

A properly secured *roof system* is the product of three essential steps:

Step 1: Calculate the *Specified Wind Loads* for the roof

Step 2: Select the type of Roof Assembly representative of the roof (conventionally insulated, or a Protected/Modified Protected Membrane Roof Assembly)

Step 3: Design the securement system using available options, depending upon the type of assembly

This Section breaks down the **RoofStar Guarantee Standards** according to these three fundamental steps. The Standards published in this Section are the minimum requirements, regardless of fastener or adhesive requirements in a *Tested Assembly*, an *Assembly with Proven Past Performance*, or any other assembly designed by other methodologies.

3.3.1 Step 1: Calculate Specified Wind Loads



The information in this Section may assist the *Design Authority* in better understanding the complexities of calculating *Specified Wind Loads*, how wind affects a roof and each of its zones, and how to properly apply fastener or adhesive configurations for each zone and its respective specified wind loads.

Specified Wind Loads are forces exerted by wind which, in the case of membrane roof *Waterproofing System*, both push and lift the *roof system* or its components. Often, the upward or uplift forces are expressed as a negative value (negative pressure), but these are influenced by many variables including, without limitation, wind speed, building height, roof slope, wall openings, roof overhangs and ground roughness.

Specified Wind Loads for membrane roof *Waterproofing System* should be calculated using the available online [Wind-RCI online wind calculator](#) or, in the alternative, another method that is its equal or superior (click [here](#) for a sample report). When the Wind-RCI calculator is not suitable (as, for example, when a building exceeds 150 feet in height), the *Design Authority* must refer to the *British Columbia Building Code, Division B, Parts 4 and Part 5* for further guidance.

The report generated by the Wind-RCI calculator will specify the wind loads for the corners, the perimeter and the roof field. These zone loads must be applied in Step 3 when determining the method of *roof system* securement.

3.3.1.1 Non-conforming Buildings

When a building's dimensions are "non-conforming" and exceed the parameters of the Wind-RCI calculator, the following standards apply:

- 1) The *Design Authority* remains responsible for the proper design of a membrane roof *Waterproofing System*, regardless of its method of securement. Refer to the *British Columbia Building Code, Division B, Parts 4 and Part 5* for further guidance.
- 2) *Roof systems* for non-conforming buildings must be engineered for proper securement to withstand wind loads.
- 3) Non-conforming building *roof systems* must incorporate RoofStar-accepted materials.

3.3.2 Step 2: Select the Type of Roof Assembly



Methods for securing the roof depend, in part, on the type of roof. How a *Conventionally Insulated System* is secured is quite different from the securement principles and methods for a *Protected Membrane Roof System*. *Conventionally Insulated Systems* that support any type of overburden should be treated like an uncovered roof, and secured accordingly (see below for options available to secure a *Conventionally Insulated System*); the *Vegetated Roof System* itself is subject to different securement methods, based on its own *Specified Wind Loads*. *Protected Membrane Roof Systems*, on the other hand, are secured completely separately. Guidance for these also is provided below.

Follow the path in **Step 3** that fits with your roof *system* design.

3.3.3 Step 3: Design Assembly Securement



The following Articles provide guidance for each of the following roof assemblies:

- *Conventionally Insulated Systems*
- Ballasted systems
- Roofs supporting an *Overburden*
- Partially replaced roofs

3.3.3.1 Conventionally Insulated Roof Systems

Whether the *Conventionally Insulated System* is covered or uncovered, it must be secured using one of three methods. These are presented below as a progression from simplicity to complexity, and from low cost (for the *Design Authority*) to high cost.

If the intent of the *Design Authority* is to replace only a part of the existing roof *system*, see **2.7.2** for guidance and options. See also **3.3.4** below.

3.3.3.1.1 Tested Assemblies

Tested Assemblies are material components that have been selected by the membrane manufacturer, installed on a specific *deck* type, secured using one of three methods (*securement system*) and tested by an independent certified laboratory to determine the limits of the assembly's ability to resist negative wind pressure (loads), or 'wind uplift'. Each of the three methods is expressed with an acronym:

MARS, or *Mechanically Attached Roof Systems* – these systems are held in place only with mechanical fasteners that are installed at the membrane layer.

PARS, or *Partially Adhered Roof Systems* – both mechanical fasteners and adhesives are used as a hybrid method of securement; the membrane is always adhered, using an applied adhesive or heat-welding.

AARS, or *Adhesive Applied Roof Systems* – these are membrane roofs secured only with adhesives and/or heat-welded components.

Only *Tested Assemblies* that have been tested by qualified facilities wholly independent of *roof system* manufacturers will be regarded by the **RoofStar Guarantee Program** as legitimate. Click [here](#) for a list of qualified testing agencies.

To find a *Tested Assembly*, follow any of the links shown above.

- 1) **The *Design Authority* is strongly encouraged to specify the application of a *Tested Assembly*, for any design of a new membrane roof *Waterproofing System* or full roof replacement of a membrane roof *Waterproofing System*.**

- 2) The *Design Authority* must use only the test observation readings that have been adjusted for the Safety Factor. This is called the *Dynamic Uplift Resistance* (DUR).
- 3) *Tested Assembly* observation readings, reduced by the Safety Factor, must equal or exceed the highest *Specified Wind Loads* for the roof. This is called the *Dynamic Uplift Resistance* (DUR).
- 4) When a *Tested Assembly* report indicates only one *system* of securement, that *system* shall be applied to all roof zones.

Figure 3.4

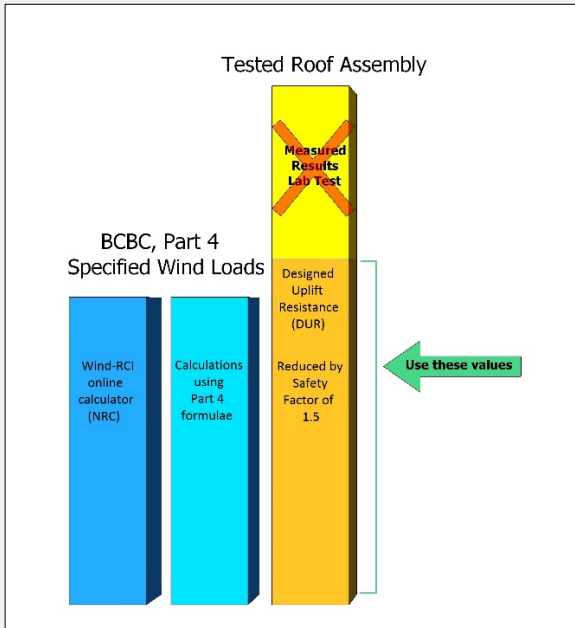

3.3.3.1.2 Roof Assemblies with Proven Past Performance

- 1) A roof *Assembly with Proven Past Performance* is a *Conventionally Insulated System* installed on a specific supporting deck that utilizes materials acceptable for the **RoofStar Guarantee Program**, and which has demonstrated a proven track record of wind uplift resistance
 - 1) for at least as long as the expected life of the new *roof system*.
 - 2) for buildings, and in conditions, that are reasonably representative of the *Project* the *roof system* will be specified for.
- 2) *Roof Systems with Proven Past Performance*
 - 1) are an acceptable alternative to a *Tested Assembly* when
 - 1) a *Tested Assembly* cannot be used.
 - 2) material components in a *Tested Assembly* are not accepted by the **RoofStar Guarantee Program**, and the *Tested Assembly* offers no suitable alternates.
 - 3) a *Tested Assembly* is not available because
 - 1) a material or *system* has not been tested.
 - 2) the *Specified Wind Loads* exceed the capacity of an available or suitable *Tested Assembly*.
 - 2) may be used for partial roof replacement.
 - 3) *Assemblies with Proven Past Performance* must be
 - 1) designed to exceed the *Specified Wind Loads* for the roof.
 - 2) supported with a signed letter of assurance, issued by the *Design Authority* or the manufacturer of the *Assembly with Proven Past Performance*, that it will perform as required.
 - 4) Approvals issued by FM Global or another underwriter, for *roof systems* capable of resisting the *Specified Wind Load* of the *Project*, may be given consideration by the **RoofStar Guarantee Program** but must be

delivered to the *Guarantor* for review and written acceptance, along with a letter of assurance from the *Design Authority* or the manufacturer.

3.3.3.1.3 Engineered Designs

When, for various reasons, a *system* of securement cannot be designed using either a *Tested Assembly* or an *Assembly with Proven Past Performance*, the *Design Authority* must have the securement *system* designed by a qualified engineer following the requirements of the *British Columbia Building Code, Division C, 2.2.1.2. Structural Design*.

3.3.3.2 Ballasted Roof Systems

NOTE: the reader must consult the Design and Application requirements for **12.1 Protected and Modified Protected Membrane Roof Systems**, and for **Part 14 THE ROOF as a PLATFORM** (with respect to *Vegetated Roof Systems*).

- 1) *Roof systems* secured with gravel ballast, pavers or both must be designed to resist wind uplift, regardless of any overburden the design may call for. To facilitate resistance to wind uplift,
 - 1) a filter fabric is required beneath gravel or paver ballast.
 - 2) a protection layer is required beneath crushed ballast.
 - 3) gravel ballast for a *Protected Membrane Roof System* must conform to
 - 1) the following minimum requirements (**Table 3.2**), subject to the calculations for wind uplift resistance:

Table 3.2 RGC Ballast Guide

XPS Insulation Thickness	Stone Ballast Required Weight	Ballast Depth (approximate)
Up to 50 mm (2")	60 Kg/M ² (12 lb./sf)	40 mm (1 ¾")
75 mm (3")	8r Kg/M ² (17 lb./sf)	60 mm (2 ¼")
100 mm (4")	108 Kg/M ² (22 lb./sf)	75 mm (3")
125 mm (5")	132 Kg/M ² (27 lb./sf)	90 mm (3 ½")
150 mm (6")	156 Kg/M ² (32 lb./sf)	105 mm (4 ¼")
175 mm (7")	180 Kg/M ² (37 lb./sf)	125 mm (5")
200 mm (8")	204 Kg/M ² (42 lb./sf)	140 mm (5 ½")

2) the appropriate design derived from [Dupont Tech Solutions 508.2 Ballast Design Guide for PMR Systems](#).

- 2) On roofs specified to utilize gravel ballast, no fewer than two parallel rows of pavers should be considered for *Corner* and *Edge* zones, to prevent or reduce wind scouring of the gravel. Pavers should be secured together when specified by the *Dupont Ballast Design Guide*.
- 3) Loose-laid membranes held in place with gravel ballast must be secured with gravel ballast having sufficient size and weight to resist wind uplift, but shall in any event meet the following minimum requirements:
 - 1) **Coverage:** 60 kg/sq. m (12 lb/ft²).
 - 2) **Ballast size:** nominal ¾" to 1½" (19.0 mm to 38.1 mm) diameter stone meeting *ASTM D 448* size #4 using *ASTM C-136*.

See also **9.3.4 Loose-laid Ballasted Membranes**.

3.3.3.3 Roofs Supporting an Overburden

- 1) Any supported *Overburden* must be installed in keeping with the designed securement methods and *systems* specified by the *Design Authority* and must equal or exceed the *Specified Wind Loads* for the roof.
- 2) *Vegetated Roof Systems (VRSs)* constructed in modules must be secured according to the methods specified by the *Design Authority*.

3.3.3.4 Partial Roof Replacement

- 1) When only a portion of an existing *roof system* is specified for replacement, the new materials must be secured to resist wind uplift. See also **1.4.2 Replacement Roofing**.
- 2) Mechanical fastening is the most reliable method for securing new materials installed over an existing roof assembly. When mechanical fastening is not practicable, the *system* of securement must conform to one of the following options:
 - a. A custom-engineered design.
 - b. A *system* design with *Proven Past Performance* (accompanied by a letter of assurance; see the requirements under **3.3.3.1.2 Roof Assemblies with Proven Past Performance**).

3.3.3.4.1 Mechanically Fastened Materials

- 1) When mechanical fastening is specified by the *Design Authority* as the securement method, the minimum number and pattern of fasteners mandated by the **RoofStar Guarantee Standards** published below prevail unless exceeded by another reliable method.
- 2) Multiple layers of insulation that are mechanically fastened must be secured together, as if they are a single layer.
- 3) Mechanical fasteners must penetrate
 - 1) steel *decks* at least 20 mm (3/4") – fasteners should penetrate the top flutes only.
 - 2) into solid dimensional lumber by at least 25 mm (1").
 - 3) through plywood sheathing by at least 19 mm (3/4").

These Standards may be exceeded by the fastener manufacturer’s published requirements.

- 4) When mechanically attached membranes are installed together with new insulation, the insulation assembly (with or without an *insulation overlay*) must be held in place independently from the membrane, with no fewer than four (4) fasteners per panel.
- 5) **Table 3.3** shows the minimum required number of fasteners, unless otherwise specified by a *Tested Assembly*, an *Assembly with Proven Past Performance* or a custom-engineered assembly. Also see the required patterns, displayed below the table:
 - 1) Fasteners must be installed no more than 150 mm (6") from panel corners, measured from each edge of the panel.
 - 2) Fasteners used to secure boards from curling, or to secure boards at slope transitions, shall be in addition to the minimum number of fasteners and plates required by the patterns shown in **Table 3.4**.

Table 3.3 RGC Mechanical Fastening (minimum requirements)

Material Dimensions	Roof Zone		
	Field	Perimeter	Corner
1200mm x 2400 mm (4’x8’)			
<i>Deck</i> Overlay supporting mechanically attached materials	4	4	4
Insulation or Insulation Overlay supporting mechanically attached materials	4	4	4
<i>Deck</i> Overlay supporting adhered materials	8	12	15
Insulation	8	12	15
Insulation Overlays	8	12	15

1200mm x 1800mm (4' x 6')			
Insulation	6	8	12
1200mm x 1200mm (4' x 4')			
Insulation	5	6	8
(Continued next page)			
900mm x 100mm (3' x 4')			
Insulation	4	6	7
600mm x 2400mm (2' x 8')			
Insulation	5	6	8
600mm x 1200mm (2' x 4')			
Insulation	4	4	5

Table 3.4 RGC Fastener pattern requirements (illustrated)

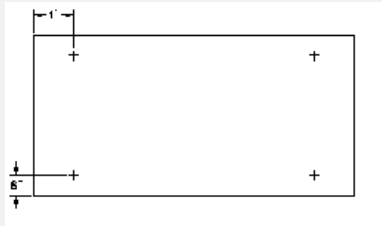
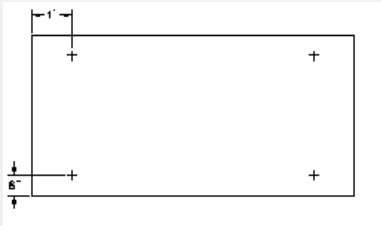
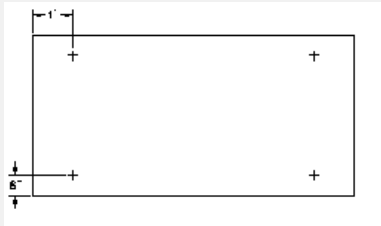
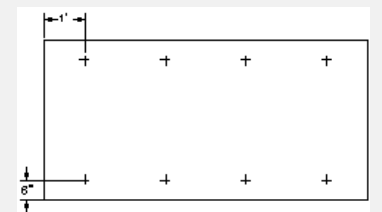
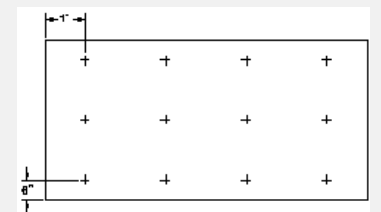
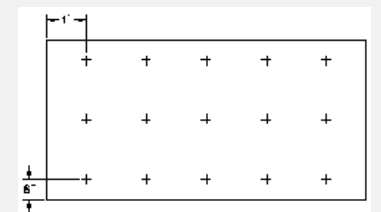
1200mm x 2400 mm (4'x8')		
Field	Perimeter	Corner
 <p>4 Fasteners</p>	 <p>4 Fasteners</p>	 <p>4 Fasteners</p>
 <p>8 Fasteners</p>	 <p>12 Fasteners</p>	 <p>15 Fasteners</p>
(Continued next page)		

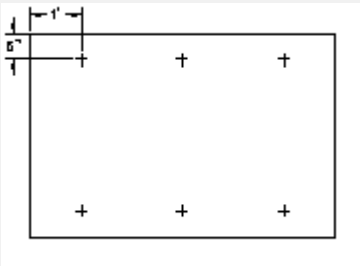
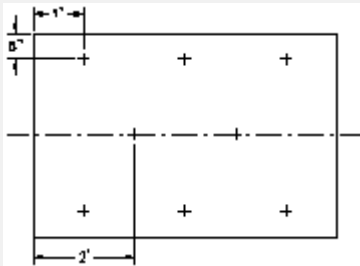
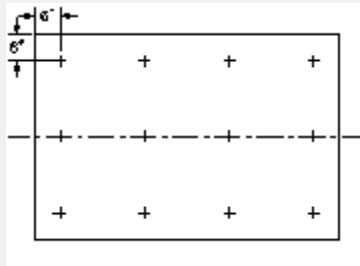
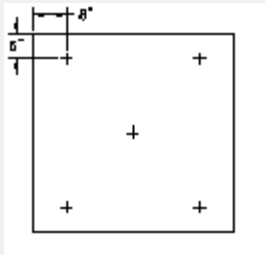
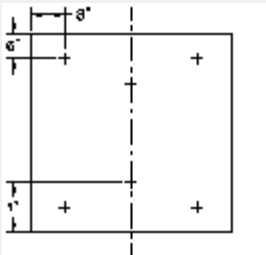
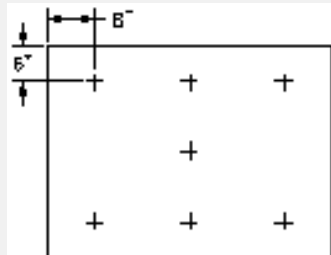
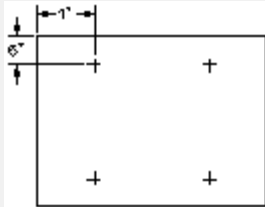
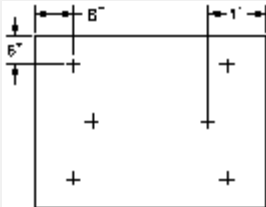
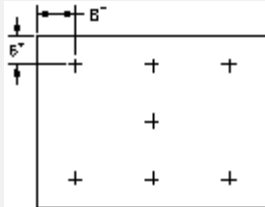
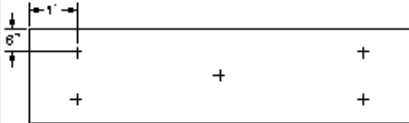
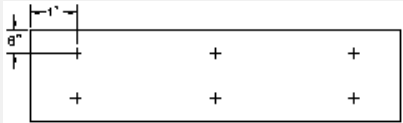
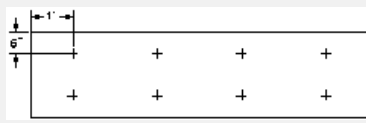
1200mm x 1800 mm (4'x6')		
Field	Perimeter	Corner
 <p>6 Fasteners</p>	 <p>8 Fasteners</p>	 <p>12 Fasteners</p>
1200mm x 1200 mm (4'x4')		
Field	Perimeter	Corner
 <p>5 Fasteners</p>	 <p>6 Fasteners</p>	 <p>8 Fasteners</p>
900mm x 1200 mm (3'x4')		
Field	Perimeter	Corner
 <p>4 Fasteners</p>	 <p>6 Fasteners</p>	 <p>7 Fasteners</p>
600mm x 2400 mm (2'x8')		
Field	Perimeter	Corner
 <p>5 Fasteners</p>	 <p>6 Fasteners</p>	 <p>8 Fasteners</p>
600mm x 1200 mm (2'x4')		
(Continued next page)		

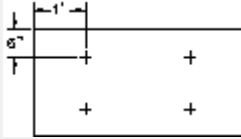
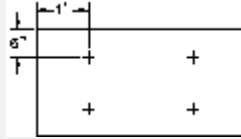
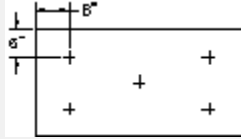
Field	Perimeter	Corner
 <p data-bbox="354 325 482 352">4 Fasteners</p>	 <p data-bbox="784 325 912 352">4 Fasteners</p>	 <p data-bbox="1219 325 1347 352">5 Fasteners</p>

NOTE: Fastener locations are for optimum uplift resistance. Fasteners may be located within 50 mm (2") of position shown in diagrams in any direction.

3.3.3.4.2 Adhesive Applied Materials

- 1) Adhesives may be used to secure new roofing materials to an existing *roof system*, provided the specific application procedures and methods are engineered by or for the *Design Authority*.
- 2) Notwithstanding the above, the minimum requirements set out in **7.3.2.4** apply.

4 MATERIALS

Click [here](#) to view all the Materials accepted for use in the **RoofStar Guarantee Program**.

4.1 General

- 1) All roofing components installed by the *Contractor* must be
 - 1) new
 - 2) accepted by the **RoofStar Guarantee Program**.
 - 3) manufactured by, or listed as acceptable to, the manufacturer of the primary field membrane or water-shedding material.

A list of all *Accepted Materials* is published in this *Manual* (see link above).

Also see **1.6 (2) RoofStar Guarantee: Coverage and Limitations** for restrictions and limitations on any roofing material, linear metal flashing, penetration flashing or drain used on a *Project* qualifying for a **RoofStar Guarantee**.

- 2) All materials must be protected from weather, properly stacked and secured above ground or the roof surface and covered by wrappers approved or recommended by the manufacturer.
- 3) All installed roofing materials that are susceptible to moisture damage must be made watertight by the end of each workday.
- 4) Metals and fasteners must be compatible with each other, to avoid galvanic corrosion which can occur when dissimilar metals come in contact with each other.

4.1.1 Definitions

Refer to the [Glossary](#) for further definitions of key terms used in this *Manual*.

Primary Material

means a roofing, waterproofing or water-shedding material which is directly exposed to the weather and which is primarily responsible for protecting secondary materials, and the building interior, from water and weather generally. Membranes, metal panels or shingles form the core of this material type.

Secondary Material

means one which forms part of the roof or waterproofing assembly and which may affect the wind resistance characteristics of the entire assembly but is not necessarily exposed to the weather.

5 DECK and WALL OVERLAYS

See more information on [Roof Deck Overlays](#) in *Section B: Essential Elements*.

5.1 General

5.1.1 Definitions

Refer to the [Glossary](#) for further definitions of key terms used in this *Manual*. See also **2.1.1 Definitions**.

5.1.2 Design

- 1) When a supporting *deck* structure or *wall* is unsuitable for the application of roofing materials, it must be covered with a **RoofStar-accepted** overlay. See **2.1 (3)** for supporting *deck* and *wall* surface requirements.
- 2) A roof *deck* overlay (also called a *system* underlay) is installed as part of the *roof system*, on the top surface of the roof *deck* but beneath the roofing materials. These products are most commonly affixed to steel *decks* to provide a level surface for the roof membrane, to support air or vapour control layers, or to serve as a thermal barrier between the roof *deck* and combustible insulation. Roof *deck* overlay materials may also be applied to other types of supporting *deck* structures, depending on the roof design criteria.
- 3) When a roof design includes any type of *Overburden*, the *deck* overlay on steel, or wood *decks* less than 25 mm (1") thick, should be at least 16 mm (5/8") thick, in order to stiffen the supporting surface and reduce *deck* deflection.

5.2 Materials

- 1) *Deck* and *wall* overlays must be suitable for, and compatible with, any membrane or panel application. Plywood, measuring at least 12.7 mm (1/2") in thickness, is acceptable as a *deck* or *wall* overlay; for roofs supporting an *Overburden*, the plywood must be at least 16 mm (5/8") thick.
- 2) Self-adhering or adhesive-applied materials should be considered as alternatives to hot-applied membranes when the substrate to which they will be applied is combustible, or when nearby structures, openings or materials present a fire hazard. In the alternative, a suitable separation or overlay material as protection from sources of heat is acceptable.
- 3) When the Building Code having jurisdiction requires a thermal barrier, an accepted *deck* overlay must be specified and installed.
- 4) *Walls* that require resurfacing for membrane application must be covered with an accepted *wall* overlay. See Accepted [Wall Overlays](#).
- 5) Fasteners used to secure *deck* overlays must be corrosion-resistant or resin-coated and must be used together with plates when specified or listed in a *Tested Assembly* report.

See also Accepted [Roof Deck Overlays](#).

5.3 Application

5.3.1 General

- 1) *Deck* overlays must be
 - 1) fully or intermittently supported along all edges by the *deck*.
 - 2) installed in a staggered pattern (offset) 300 mm (12") from adjacent board rows. A minus offset tolerance of 50 mm (2") maximum will be permitted to compensate for variance in the manufacturer's tolerance of differing board widths and lengths.
 - 3) affixed to the *deck* with either or both
 - 1) mechanical fasteners.

- 2) proprietary polyurethane foam adhesives acceptable to the primary *roof system* manufacturer to meet or exceed the requirements set out in **Part 3 SECURING the ROOF ASSEMBLY**.
- 4) independently fastened to the *deck* in keeping with either of the following:
 - 1) at least four (4) fasteners (with plates) per 1200 x 2400 (4'x8') sheet, or
 - 2) as required by a *Tested Assembly*, when part of a **PARS** or **MARS Conventionally Insulated System**.
- 2) *Wall* overlays
 - 1) must be applied to existing sheathing, where existing sheathing is not an acceptable substrate.
 - 2) may be mechanically fastened or adhered.
 - 3) may be replaced with an accepted material.

5.3.2 Steel Decks

- 1) RoofStar-accepted *deck* overlay boards used as a thermal barrier to achieve a specific fire rating must conform to the applicable code and insurance requirements for the *roof system*.
- 2) When the *roof system* is uninsulated, the *deck* must be overlaid with at least one 12.7 mm (1/2") thick layer of either
 - 1) moisture resistant gypsum core *deck* overlay board.
 - 2) plywood.

5.3.3 Concrete Decks

- 1) A *deck* overlay board is not mandatory on a concrete supporting *deck*.

5.3.4 Wood Decks

- 1) A mechanically fastened overlay board is required for any *deck* structure that does not meet the *deck* fastening criteria set out in **2.3.3.3 Wood**.
- 2) Regardless of the type of *deck* overlay selected by the *Design Authority*, the overlay boards shall be installed in a staggered pattern (offset) 300 mm (12") from adjacent board rows. A minus offset tolerance of 50 mm (2") maximum will be permitted to compensate for variance in the manufacturer's tolerance of differing board widths and lengths.
- 3) Adhering a primary roof membrane directly to a wood *deck* is not acceptable.
- 4) Notwithstanding Article 3 above, a self-adhered air or vapour control layer may be applied to a supporting wood *deck*.
- 5) Mechanically fastened or loose-laid membranes applied directly to a supporting wood *deck* structure do not require a *deck* overlay board unless specified by the membrane manufacturer.

5.3.5 Walls

- 1) Where the *wall* surface is unsuitable to receive a membrane, it must be covered with an accepted overlay panel material (refer to **Division C: Accepted Materials** in this *Manual*).
- 2) *Wall* overlay panels must be
 - 1) mechanically fastened with screw fasteners spaced no more than 300 mm (12") O.C. vertically and horizontally, in alignment with structural supports, and placed
 - 1) at the perimeters.
 - 2) at the corners.
 - 3) in the field.
 - 2) adhered with a polyurethane adhesive, applied with a continuous z-patterned ribbon spaced no less than 300 mm (12") apart.

6 AIR and VAPOUR CONTROLS

See more information on [Air and Vapour Control](#) in **Division B: Essential Elements**.

6.1 General

6.1.1 Intent

Air and vapour control layers, along with thermal barriers, water resistive barriers and water-shedding surfaces, serve to separate the outside environment from the interior environments of a structure. Continuous air control layers are perhaps the most critical. Building Codes in force in each jurisdiction, and the *National Energy Code (2011)*, require the selection and proper installation of “a continuous air barrier system comprised of air-barrier assemblies to control air leakage into and out of the conditioned space” (NEC 2011).

Continuity of the air and vapour control layers from the wall systems and roof systems is essential to the satisfactory performance of either or both. Therefore, proper connection between air and vapour control systems is essential, and the responsibility of both the *Design Authority* and trades constructing walls and roofs.

Air control layers control “flow of air through the building enclosure, either inward or outward” (*Guide for Designing Energy Efficient Building Enclosures, Homeowner Protection Office*). Controlling air flow into and out of conditioned spaces affects the performance of “thermally efficient enclosure assemblies” (ibid), impacts the potential for condensation in between materials, and directly influences rainwater penetration of the building envelope. Some air control layers are considered permeable, others air-impermeable or ‘airtight’. The suitability of one over the other, in the application of a roofing system, is left to the discernment of the *Design Authority*. **Consequently, the RoofStar Guarantee Program strongly recommends that designers and builders of roof systems intended to qualify for a RoofStar Guarantee carefully consider the regulatory design and installation requirements for effective, continuous air control systems.**

Vapour control layers regulate or prohibit the movement of water vapour from one space to another by means of diffusion. Consequently, these control layers are referred to as either vapour-permeable or impermeable. Diffusion is a slow process, in contrast to air movement, and its regulation is not always mandatory or even desirable. Therefore, because continuous vapour control layers “are not needed within all climate zones and assemblies”, they are considered non-critical and may be left to the discretion of the *Design Authority*. **Nevertheless, where continuous vapour control layers are required and specified by provincial or municipal building codes (current and in force), the RoofStar Guarantee Program requires that a suitable vapour control system be selected by the Design Authority and properly installed by the roofing contractor in conformity with the vapour control layer manufacturer’s published instructions, and with the Design Authority’s specified details.**

Any references in this *Manual* to installation methodologies, and any construction details that show air and vapour control layers, are merely illustrative and not prescriptive. **Installers of continuous air and vapour control layer systems are urged to understand and comply with best practices for their application.**

6.1.2 Limitations and Exclusions

- 1) Air and vapour control layer performance is not part of the **RoofStar Guarantee**, and air and vapour control materials are not listed in the Accepted Materials Division of this *Manual*. Therefore, the decision to specify air and vapour control layers, the placement of continuous air and vapour control layers in relation to a roof assembly and its components, and the selection of suitable materials for that application, is the sole responsibility of the *Design Authority*. **The Design Authority is urged to review and consider the performance characteristics of materials available for such applications.**
- 2) Neither the **RoofStar Guarantee Program** nor the *Contractor* will accept any responsibility for damage to, or failure of, the roof system caused by the use or absence of air or vapour control layers.

- 3) In some roof assembly designs, the required underlayment may serve as an air control layer, vapour control layer, or both; this is dependent upon the properties of the material to be used and will be subject to the designer's modelling of the assembly. Consult the Technical Data Sheets for suitable materials.

6.1.3 Air and Vapour Control for High-Humidity Building Interiors

- 1) Careful consideration should be given to the performance characteristics of air and vapour control layers when specifying such a membrane for roof assemblies constructed over high-humidity building interiors. These types of building interiors include (but are not limited to)
 - 1) Swimming pools
 - 2) Commercial laundry facilities
 - 3) Large aquariums
 - 4) Paper mills

Roof systems for facilities such as these, with high-humidity environments, may be susceptible to the accumulation of moisture within the *Roof System* unless effective air and vapour controls are installed.

6.2 Materials

- 1) The material selected for air and vapour control layers must be compatible with any other materials in the roof or *wall assembly* to which the control layer may come in contact. This includes, without limitation, contact with primers and adhesives, substrates, solvents and cleaners.
- 2) Self-adhering or adhesive-applied materials should be considered as alternatives to torch-applied membranes when the substrate to which they will be applied is combustible, or when nearby structures, openings or materials present a fire hazard. In the alternative, a suitable separation or overlay material as protection from open flame is acceptable. The application of materials to a combustible surface, using a torch, is strictly prohibited.
- 3) Fully supported air and vapour control layers should possess a minimum published static puncture resistance rating of 150 N (34 lbf) (ref. *CGSB-37.56-M* for both test method and standard limits) and be either self-adhering or torch-applied; a high puncture resistance is necessary for the membrane to withstand accidental damage during construction. For unsupported air and vapour control layers, see **6.2 (4)** below. Therefore, while responsibility for the selection of suitable air and vapour control layers rests with the *Design Authority*, a roof designed and built to qualify for a **RoofStar Guarantee** shall not include either polyethylene sheet plastic or bitumen-impregnated kraft paper.
- 4) Notwithstanding any of the foregoing, the **RoofStar Guarantee Program** strongly recommends that any air or vapour control systems be installed over a smooth, continuous plane (for example, concrete or plywood). Consequently, a **deck overlay** board installed on corrugated steel roof decks is highly recommended. Where no **deck overlay** board is installed and the air and vapour control layers are partially unsupported (for example, on a steel *deck*), the control layers each must have a published static puncture resistance of at least 400 N (90 lbf). Furthermore, both the side laps and end laps must be fully supported.
- 5) Should the air or vapour control layers be used as a temporary roof during *Project* construction by either the *Contractor* or by other trades, a minimum 2mm thick bituminous membrane is recommended.
- 6) Because curing concrete releases considerable moisture that can compromise the performance of a *roof system*, a vapour control layer installed on new concrete *decks* (28 days or older) must be selected to prevent condensation inside the *roof system*. A membrane with a permeability of 0.01 perms (Class I) is recommended. Nevertheless, the selection of the vapour control material is the responsibility of the *Design Authority*.

6.3 Application

- 1) Proper installation and continuity of air and vapour control layers within the *roof assembly* is the responsibility of the *Contractor*. Therefore, air and vapour control layers in the *roof assembly* must

- 1) extend beyond the end of the *roof assembly* at least 100 mm (4"), in new construction, to provide sufficient room for the installation of matching control layers to so that they provide a positive (water-shedding) lap seal union between courses of material
- 2) be sealed to matching control layers in the *wall assembly*, for roof replacement *Projects*
- 2) Installation must be smooth and uniform, without wrinkles or fish-mouths, and must also conform to the manufacturer's published requirements and the *Design Authority's* design details.
- 3) All membrane side and end laps must be fully supported, in the field and at transitions with curbs, parapets, *walls* and penetrations.

See Figures 6.3.1-1 and 6.3.1-2.

Figure 6.3.1-1

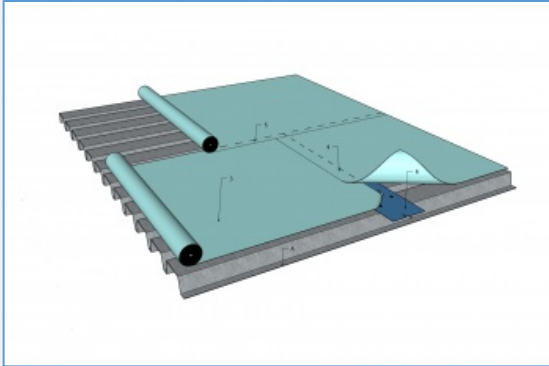
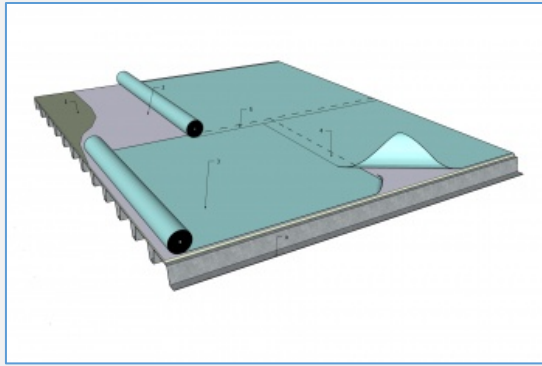

Figure 6.3.1-2



Click on either of the images above to link to the Construction Detail.

- 4) The application of materials to an unprotected combustible material, using a torch, is strictly prohibited.
- 5) All combustible materials **MUST** be protected from open flame by an acceptable separation or overlay material. This includes, without limitation, combustible materials
 - 1) on *decks, walls*, blocking, and cants.
 - 2) hidden or obscured within voids, cracks or orifices.
- 6) When a torch-applied base membrane is specified, all joints between overlay panels, and at roof-wall transitions, must be sealed with the primary membrane manufacturer's approved self-adhered membrane or tapes. Alternatively, refer above to **10.3.3 Alternative Approaches to Membrane Flashing** in the **RoofStar Guarantee Standards for SBS Modified Bitumen Membrane Systems**.

7 INSULATION

See more information on [Insulating the Roof](#) in **Division B: Essential Elements**.

7.1 General

7.1.1 Definitions

Heat-resistant insulation

means insulation that resists heat and will not physically or chemically change when exposed to heat greater than 70°C (158°F), including **heat from** liquefied bitumen. Insulation boards of this type include fibreboard, polyisocyanurate and mineral wool. Note that “heat-resistant” does not mean or even infer 'fire-proof'. While some heat-resistant insulation materials will resist burning for a period of time, only mineral wool insulation will not burn.

Heat-sensitive insulation

means insulation that may be physically or chemically altered when exposed to heat greater than 70°C (158°F) - for example, heat from a torch or from liquefied bitumen. Heat-sensitive insulation includes EPS, XPS and Polyurethane.

See the [Glossary](#) for other terms used in this Part.

7.1.2 Design

7.1.2.1 RoofStar 15-Year Guarantees

- 1) All curbs and sleepers that impede drainage or are wider or longer than 1200 mm (48”) must incorporate crickets to provide positive slope to drains.

7.1.2.2 All Projects

- 1) The use of thermal barrier between the roof *deck* and the insulation is the responsibility of the *Design Authority* and may be required by the Building and Fire Code having jurisdiction. See also **Part 5 DECK and WALL OVERLAYS**.
- 2) Consult the Building Code having jurisdiction for the minimum required thermal resistance of the roof assembly.
- 3) **Insulation materials rely on various standards for the determination of thermal resistance, which means that not all data can be easily compared. Furthermore, not all insulation products perform with consistent thermal resistance as temperature changes, and some insulation performance declines with age. The *Design Authority* is therefore urged to consider the Long-term Thermal Resistance (LTTR) for each product, in relation to its placement within the roof assembly and the anticipated outside and interior climates of the building.**
- 4) In warm seasons, the roof surface may reach temperatures higher than 85°C (185°F), affecting the performance and stability of some insulation. Combining insulation types in a roof assembly may help mitigate these temperature swings and consequential distortion of the assembly. The *Design Authority* therefore must consider these variables when specifying materials and their installation.
- 5) When heat-sensitive insulations are used in the primary thermal assembly, they must be covered with a heat-resistant insulation at least 50 mm (2”) thick. See also **7.1.2 (9)** below.
- 6) Insulation assemblies with a cumulative thermal resistance greater than RSI-2.64 (R-15) (based on published LTTR values measured at 24°C) must be installed in multiple layers that are offset and staggered (see **7.3 Application**). Within that multi-layered assembly, any single layer of insulation may have a thermal resistance greater than RSI-2.64 (R-15) provided no one layer exceeds 60% of the cumulative thermal resistance of the combined assembly of insulation and insulation overlay boards.

See **Figure 7.1**.

Figure 7.1

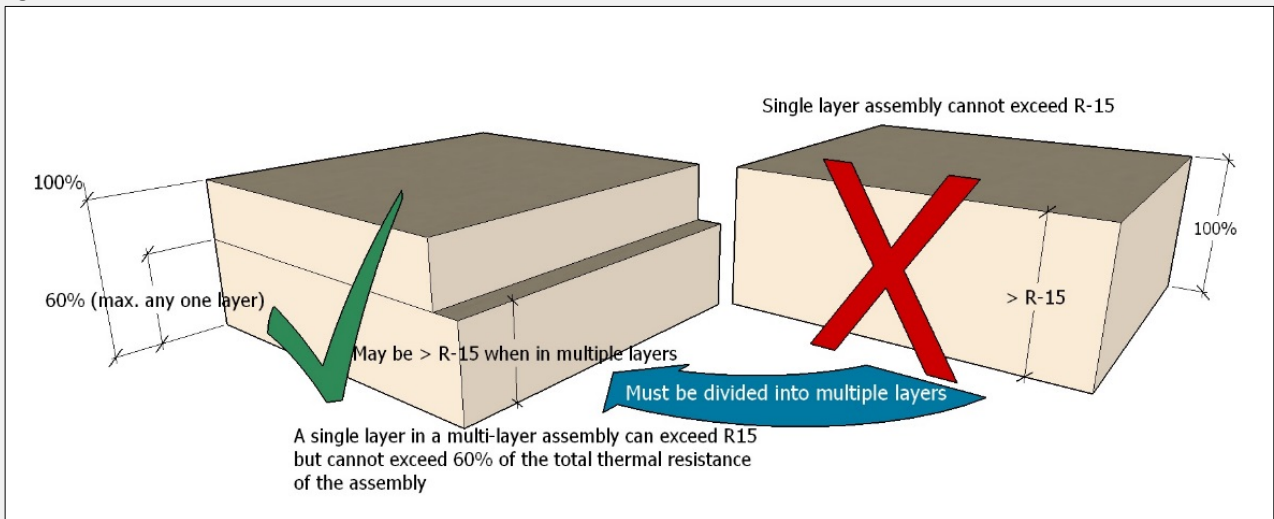

- 7) Tapered insulation can be utilized to slope the surface of the roof assembly to achieve adequate drainage (see **2.2 Roof Slopes**). The thermal resistance of tapered insulation may be used in calculating the overall thermal performance of the roof assembly and may vary depending upon the layout of the sloped insulation package, but this is at the discretion of the *Design Authority*.
- 8) **Tapered insulation**
 - 1) may be located within the roof system to slope the surface of the roof assembly to achieve adequate drainage (see **2.2 Roof Slopes**).
 - 2) may be used in calculating the overall thermal performance of the roof assembly and may vary depending upon the layout of the sloped insulation package, but this is at the discretion of the *Design Authority*.
 - 3) greater than 150 mm (6") in thickness shall be installed in multiple soldiered layers.
 - 4) that is *heat-sensitive* and manufactured to cover the entire roof area (commonly referred to as a "full slope" or "taper package") must be installed beneath at least one layer of flat board heat-resistant insulation with a minimum thickness of 50 mm (2").
 - 5) used only as crickets to promote drainage over limited areas of the roof
 - 1) should be manufactured of heat-resistant insulation, but when crickets are manufactured from heat-sensitive insulation they should be covered with a layer of heat-resistant insulation at least 50 mm (2") thick.
 - 2) may be installed directly over a roof deck, although this is not recommended. See **8.1.1 Design** for overlay requirements.
- 9) Regardless of average thermal resistance calculations for the roof assembly, drain sumps should be adequately insulated, based on the regional location of the building. See **11.1.2 (1)** for drain sump design.
- 10) Mineral wool insulation panels must be fastened or adhered according to the manufacturer's published instructions and tested assemblies, but in any event must conform to the following **RoofStar Guarantee Standards**, which are summarized as follows:
 - 1) Only bitumen-coated Mineral Wool insulation may be used in the top-most layer of insulation, or may be secured with adhesive.
 - 2) A Non-Coated Mineral Wool base insulation layer is permissible only by mechanically fastening, but may not have additional insulation layers adhered to it.
 - 3) When mineral wool insulation is mechanically fastened, a 12 mm (1/2") insulation overlay board is required, whether or not overburden is present.

- 4) **Roofs without overburden** – an insulation overlay board is not required when bitumen-coated mineral wool insulation is adhered as a single layer, or when it is adhered as the top layer in a multi-layer assembly.
- 5) **Roofs with overburden** – mineral wool insulation in a roof assembly that will support an overburden must be overlaid with an insulation overlay board at least 12 mm (1/2”) thick, irrespective of the method by which the insulation is fastened.

Optional combinations are illustrated below (hover over any image and click on the link to expand it):

Figure 7.2

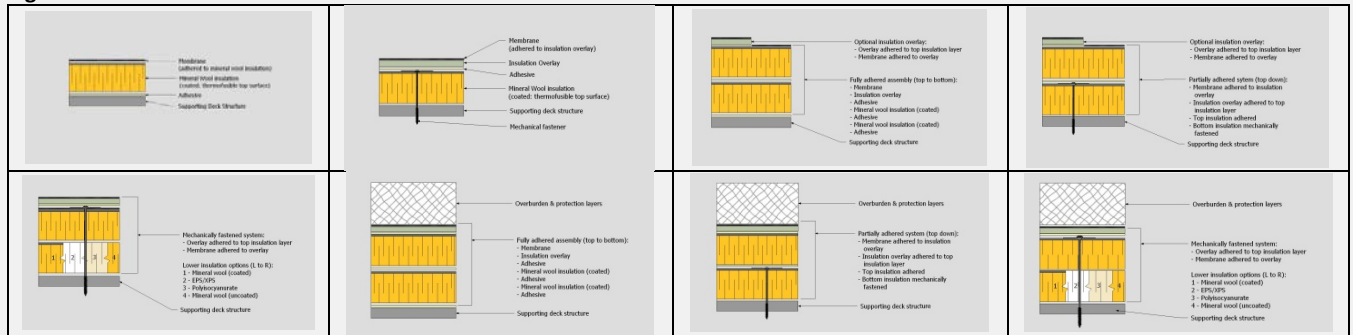

7.2 Materials

Only insulation boards accepted for use in the **RoofStar Guarantee Program**, and acceptable to the membrane manufacturer, may be used to qualify for a **RoofStar Guarantee**. This includes insulation used in Tested Assemblies (see **3.2.1 Material Substitution in Tested Assemblies**). Specific standards and limitations for commonly used insulation types are listed below. To see the full range of insulation products accepted for the **RoofStar Guarantee Program**, refer to the listing of accepted [Insulation](#) materials.

- 1) All insulation types shall have a minimum compressive strength of 110 KPa (20 psi) when installed without a cover board under mechanically attached membranes.
- 2) **Polyisocyanurate:**
 - 1) Only polyisocyanurate insulation with non-organic facers (e.g. fibreglass) are acceptable for use in the **RoofStar Guarantee Program**. In addition, manufacturers’ product identification labels are required for all Polyisocyanurate insulation packaging and the date of manufacture must be provided on all product labels.
 - 2) Polyisocyanurate insulation, which is manufactured to various dimensions and board thicknesses, is suitable only for conventionally insulated roof assemblies and may be manufactured in sloped packages, for individual crickets or for full roof area application.
- 3) **Mineral wool** – manufactured to various dimensions and board thicknesses, and may be manufactured in sloped packages, for individual crickets or for full roof area application. Mineral wool insulation is suitable only for conventionally insulated roof assemblies.
- 4) **Expanded Polystyrene (EPS)** – EPS insulation is manufactured in various board dimensions and may be manufactured in sloped packages, for individual crickets or for full roof area application. EPS is suitable only for conventionally insulated roof assemblies.
- 5) **Extruded Polystyrene (XPS)** – XPS insulation is a closed-cell material manufactured in various board dimensions, and is mainly used in a **Protected Membrane Roof Assembly**. Only [Extruded Polystyrene Insulation](#) (conforming to CAN / CGSB-51.20-M87, Type 4) may be used on **Protected Membrane Roof Assemblies**. For more about PMRAs, see [Protected and Modified Protected Roof Systems](#). See also **Part 14 THE ROOF as a PLATFORM**.
- 6) Material dimensions:
 - 1) The maximum width and length of any adhered insulation panel shall be 1200 mm (4’) (see also **3.3.3.4.2 Adhesive Applied** and **7.3.2 (4)** below).

- 2) The maximum width and length of insulation boards installed with mechanical fasteners is limited only by the manufacturer.
- 3) Insulation installed directly over a fluted steel *deck* must be thick enough to span the flutes under live loads, without risk of cracking or breakage.
- 4) While minimal insulation panel thicknesses are permissible for some designs, the *Design Authority* should consider the constructability of the roof system from a material handling perspective. Therefore, when materials are by their nature breakable, the specifier should consider specifying a thicker panel.

7.3 Application

7.3.1 General

7.3.1.1 15-Year Guarantees

- 1) See the requirements for a **RoofStar 15-Year Guarantee** in 7.1.2.1.
- 2) An insulation overlay is required for all insulated *systems*, regardless of the insulation type, and overlays must
 - 1) be at least 6.4 mm (1/4") thick.
 - 2) possess a compressive strength of at least 690 kPa (100 psi).

7.3.1.2 All Projects

- 1) Insulation must be fastened or adhered to resist the Specified Wind Loads calculated for the roof *system*. See also **Part 3 SECURING the ROOF ASSEMBLY**.
- 2) Roof system components adhered with two-component low-rise polyurethane foam must be
 - a. installed immediately in wet adhesive (before a surface skin develops).
 - b. properly placed and weighted in wet adhesive until cured.
- 3) Hot bitumen used to adhere a roof assembly
 - a. must be applied at minimum rates and temperatures based on the type of product, as published by the material manufacturer and in the RoofStar Guarantee Standards for Built-up Roof (BUR) Systems.
 - b. may be applied on slopes up to 1/2:12 (for steeper slopes, select a different method of securement).

7.3.2 Alignment, Sizing and Support

- 1) Insulation boards must be firmly supported.
- 2) Insulation boards should be square and should make firm, full contact with adjacent panels. Gaps greater than 6 mm (1/4") around boards must be filled with expanding spray foam.
- 3) Insulation board joints must be offset at least 300 mm (12"), both for adjacent layers and for adjacent rows; a minus offset tolerance of 50 mm (2") maximum is permissible (see **Figure 7.3**). Insulation offsets are not required for
 - 1) sloped insulation boards that are generally installed soldiered fashion to adjacent rows.
 - 2) the first layer of overlay board, installed on top of heat sensitive insulation, which may be soldiered to facilitate joint taping.

See also **8.3.1 General**.

Figure 7.3

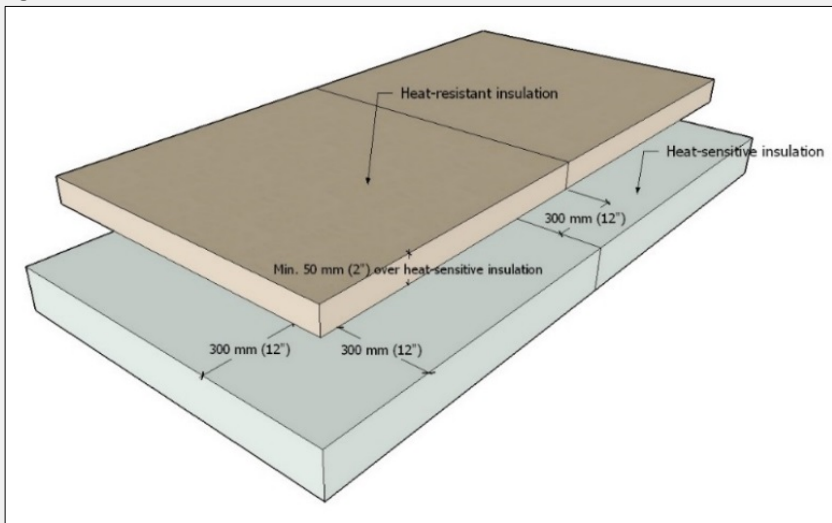

- 4) Unless specified otherwise by a *Tested Assembly* or in an engineered specification (see **3.3.3.4.2 Adhesive Applied Materials**), the following minimum standards apply to adhesive-applied insulation:
- 1) The maximum width and length of any adhered insulation panel shall be 1200 mm (4').
 - 2) The maximum length of any insulation overlay panel shall be 2400 mm (8').
 - 3) When Extruded Polystyrene insulation is adhered with a two-component low-rise polyurethane foam adhesive, the faces of the insulation board must be roughened by planing to achieve optimal adhesion.
 - 4) Two-component low-rise polyurethane foam adhesive ribbons must be applied
 - 1) in **parallel runs or in a Z-pattern**, no more than 150 mm (6") from any edge of the board and spaced no more than 300 mm (12") apart.
 - 2) to a clean, dry and contaminant-free surface.
 - 3) in ribbon widths specified by the adhesive manufacturer or, in the absence of manufacturer requirements, 19 mm (3/4") wide.
 - 5) Roof *system* components adhered with two-component low-rise polyurethane foam must be
 - 1) installed immediately in wet adhesive (before a surface skin develops).
 - 2) properly placed and weighted in wet adhesive until cured.
 - 6) Hot bitumen used to adhere a roof assembly
 - 1) must be applied at minimum rates and temperatures based on the type of product, as published by the material manufacturer and in the **RoofStar Guarantee Standards for Built-up Roof (BUR) Systems**.
 - 2) may be applied on slopes up to 1/2:12 (for steeper slopes, select a different method of securement).

8 INSULATION OVERLAYS

8.1 General

- 1) Insulation overlay boards are installed in most conventionally insulated roof assemblies to
 - 1) protect heat-sensitive insulation materials from damage by heat and flame.
 - 2) protect insulation materials from accidental impact.
 - 3) provide dimensional stability to the roof system.
 - 4) distribute dead loads from heavy overburdens or equipment installed on top of the finished roof assembly.
 - 5) ensure the membrane performs as it should.
 - 6) provide a suitable substrate for membrane application.
- 2) Insulation overlay boards may be mechanically attached or adhered, depending upon the insulation type and the design requirements of the roof assembly as a whole. See more information on [Insulation Joints and Overlays](#) in **Division B: Essential Elements**.

8.1.1 Design

8.1.1.1 RoofStar 15-Year Guarantee

- 1) An insulation overlay is required for all insulated systems, regardless of the membrane or insulation type, and overlays must
 - 1) be at least 6.4 mm (1/4") thick.
 - 2) possess a compressive strength of at least 690 kPa (100 psi).

8.1.1.2 All Projects

- 1) Notwithstanding the requirements in **Part 7** concerning heat-sensitive insulation, an insulation overlay of one or more layers is required over all flat and sloped board-type insulation, and on insulation installed on vertical surfaces, when
 - 1) the compressive strength of the insulation is less than 110 KPa (20 psi).
 - 2) the membrane is self-adhered or will be applied with a torch flame, adhesives or hot bitumen.
 - 3) a conventionally insulated roof assembly supports an overburden; these roof systems must be designed with at least one layer of adhered composite insulation overlay
 - 1) no less than 12.7 mm (½") thick.
 - 2) with a minimum compressive strength of 620 kPa (90 psi).
- 2) The requirement to use an insulation overlay does not apply to the field application of
 - 1) self-adhered membranes
 - 1) expressly accepted by the RGC for application directly on specific insulation types without the use of an overlay.
 - 2) expressly approved (in published literature) by the manufacturer for application directly on an insulation panel.
 - 2) torch-applied membranes installed directly on mineral fibre insulation treated with a thermofusible bitumen top surface. This exception is subject to the standards for mineral wool insulation published in **Part 7 INSULATION**.
- 3) When an overlay board is required over mineral wool insulation, the overlay board must be a moisture resistant gypsum core board measuring at least 12.7 mm (1/2") thick. See also **7.2** concerning *Mineral Wool Insulation*.
- 4) Heat-sensitive crickets used in membrane systems applied with a torch flame or hot bitumen must be overlaid using either of the following approaches:
 - 1) one layer of panels,
 - 1) at least 12.5 mm (1/2") thick.
 - 2) offset from insulation joints by at least 300 mm (12").

- 3) continuously sealed with a flame-impervious tape along all joints with adjacent panels.
- 2) two layers of panels,
 - 1) each at least 4.8 mm (3/16") thick.
 - 2) offset from each other, from the adjacent layer, and from insulation joints by at least 300 mm (12").

See also **14.1.2.1 General**.

8.2 Materials

See [Insulation Overlays](#) accepted for use in *RoofStar Guaranteed* roof systems.

Table 8.1 Insulation Overlay Minimum Thicknesses

Material	Minimum Thickness - mm (in.)
Asphaltic Core Board	4.8 (3/16")
Moisture resistant gypsum core board	6.4 (1/4")
High-density Insulation Board	12.7 (1/2")
Composite and Laminated Overlay Board	6.4 (1/4")
Fibreboard	As listed in this Manual
Mineral Wool	As listed in this Manual

- 1) Regardless of the type of insulation overlay, the overall thickness of insulation overlays shall not exceed 50 mm (2"). See **Table 8.1** for RoofStar-accepted materials and minimum thicknesses.
- 2) Asphalt or paraffin-impregnated coated fibreboard roof insulation adhered with hot asphalt or an asphalt-based adhesive must be asphalt-coated on the top and bottom surface (minimum coated two-sides).
- 3) Fire guard tape must be 150 mm (6") wide
 - 1) self-adhering modified bituminous tape acceptable to the membrane manufacturer.
 - 2) Type IV fibreglass felt or No. 15 organic felt, applied with hot bitumen or cold adhesive.

8.3 Application

8.3.1 General

8.3.1.1 RoofStar 15-Year Guarantee

- 1) See the requirements for a *RoofStar 15-Year Guarantee* in **8.1.1.1**.

8.3.1.2 All Projects

- 1) See the Design requirements in **8.1.1 Design**.
- 2) Fiberboard shall not be used as an insulation overlay beneath torch-applied membranes.
- 3) Insulation overlays
 - 1) should be square and should make firm, full contact with adjacent panels unless specified otherwise by the manufacturer.
 - 2) must be offset at least 300 mm (12") from the joints of the insulation layer; a minus offset tolerance of 50 mm (2") maximum is permissible.
- 4) When multiple layers of an insulation overlay are specified, the joints between boards must be offset/staggered at least 300 mm (12") from adjacent layers and rows. See **Figure 8.1**. See also **Part 7 INSULATION**.

Figure 8.1

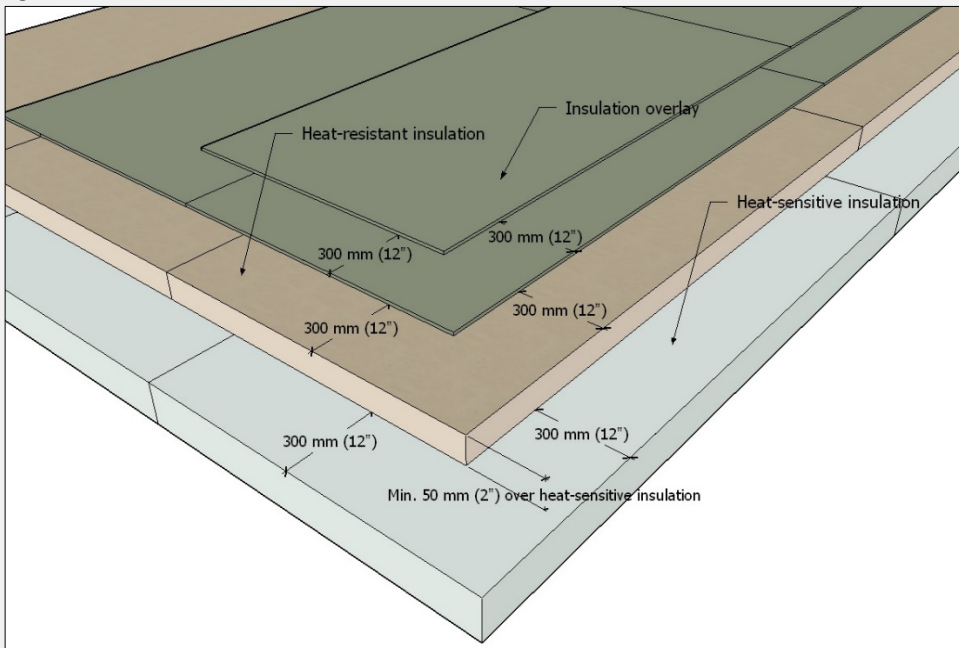

5) **Mechanical securement:**

- 1) When mechanically attaching insulation overlay boards, the insulation and overlay boards may be fastened together as one assembly. Unless otherwise indicated by the system requirements in a *Tested Assembly*, follow the fastener patterns set out in **Part 3 SECURING the ROOF ASSEMBLY**.
- 2) When a composite overlay with an integrated base membrane is mechanically fastened over insulation, fasteners and plates used in the field of each panel must be covered with torch-applied polyester or composite-reinforced membrane patches that extend past the edge of each plate at least 50 mm (2").

6) **Adhered securement:**

- 1) Adhered composite or moisture resistant gypsum core board overlays measuring at least 12.7 mm (1/2") thick must be used when
 - 1) conventionally insulated roof assemblies support an overburden (overlays must provide compressive strength of at least 620 kPa (90 psi).
 - 2) mandated by the standards for mineral wool insulation (see **7.1.1.2 (11)**). See also **Part 14 The ROOF as a PLATFORM** for design and construction standards.
- 2) Roof system components adhered with two-component low-rise polyurethane foam must be
 - 1) installed immediately in wet adhesive (before a surface skin develops) applied
 - 1) in parallel runs or in a Z-pattern, no more than 150 mm (6") from any edge of the board and spaced no more than 300 mm (12") apart.
 - 2) to a clean, dry and contaminant-free surface.
 - 3) in ribbon widths specified by the adhesive manufacturer or, in the absence of manufacturer requirements, 19 mm (3/4") wide.
 - 2) properly placed and weighted in wet adhesive until cured.
- 3) Hot bitumen used to adhere a roof assembly
 - 1) must be applied at minimum rates and temperatures based on the type of product, as published by the material manufacturer and in the **RoofStar Guarantee Standards** for Built-up Roof (BUR) Systems.
 - 2) may be applied on slopes up to 1/2:12 (for steeper slopes, select a different method of securement).

8.3.2 [NOT USED]

8.3.3 [NOT USED]

9 FIELD MEMBRANE

See more information on [Low-slope Membranes](#) in *Essential Elements*.

9.1 General

Application methods for single-ply membranes commonly include the following:

- 1) **Mechanically fastened:**
 - 1) **In-seam fastening.**
 - 2) **Induction welded.**
 - 3) **Bar and cover securement.**
- 2) **Adhered:**
 - 1) **Self-adhering** (typically membranes with an adhesive backing covered by a release film that protects the adhesive from contamination; release films are removed at the time of installation).
 - 2) **Adhesive-applied** (using synthetic adhesives that are rolled or brushed onto the membrane and the substrate).
 - 3) **Hot bitumen adhered** (sometimes referred to as 'hot-mopped', 'hot-applied' or simply 'mopped', this application method is used with fleece-backed membranes).
- 3) **Loose-laid and ballasted.**

9.1.1 Design

9.1.1.1 RoofStar 15-Year Guarantee

- 1) Refer to **1.3.1 RoofStar 15-Year Guarantee** for general requirements, to qualify the *Project* for a **RoofStar 15-year Guarantee**.
- 2) See **Table 9.2** for membranes and application types that qualify for a **RoofStar 15-Year Guarantee**.

9.1.1.2 All *Projects*

- 1) All membrane-type waterproofing assemblies (together with the supporting *deck* structure they are designed for) shall meet the requirements of the *British Columbia Building Code* and the **RoofStar Guarantee Standards**, and shall be (when applicable)
 - 1) a *Tested Assembly*
 - 2) an *Assembly with Proven Past Performance*.
 - 3) an assembly with custom-engineered securement.

See also **3 SECURING the ROOF ASSEMBLY**.

- 2) The specifications, details, and installation techniques must conform to the membrane manufacturer's requirements, unless exceeded by these **Standards**.
- 3) Membranes must be selected for their
 - 1) performance characteristics in relation to the intended use of the roof, as for example puncture resistance or reflectivity and reduced heat absorption.
 - 2) application methodology, which may be limited by
 - 1) the type of *supporting deck* or substrate to which it will be applied.
 - 2) its overburden (Only **PARS** and **AARS** assemblies are permitted when a *Conventionally Insulated System*, or a portion of it, is designed to support any type of load; pavers supported by pedestals are an exception. This is subject to the limitations and standards in **14.1.2 Design**).
 - 3) compatibility with chemicals or other contaminants including, without limitation,
 - 1) animal or vegetable grease.
 - 2) hot pipes (release valves).
 - 3) petroleum products or biproducts.

- 4) miscellaneous fluids, detrimental to the membrane.
- 5) pool or garden chemicals and fertilizers.
- 6) pet urine.
- 7) bird excrement.
- 8) refrigerants.

Membranes should be protected from contamination. Consult the membrane manufacturer for their advice and recommendations.

- 4) An intermediate separation layer must be installed between all fully adhered membranes and rough *deck* surfaces in a *Protected Membrane Roof System*.
- 5) Membranes
 - 1) must be fully adhered when specified for a *Protected Membrane Roof System*. See also **1.6 RoofStar Guarantee: Coverage and Limitations**.
 - 2) may not be adhered directly to a
 - 1) concrete *deck* (this Standard does not apply to accepted hot-mopped membranes, or to membranes adhered to concrete *walls*).
 - 2) wood *deck*.
- 6) When a *Conventionally Insulated System* will be accessed at least once per month for maintenance of serviceable equipment, the design must incorporate designated walkways
 - 1) to protect the primary membrane at roof access points, equipment service locations and along travel routes.
 - 2) that facilitate drainage and drying ([Pedestals and other paver supports provide airflow for drying surfaces and assist in leveling](#)).
 - 3) that are properly secured against movement by wind
 - 4) that may be constructed with
 - 1) accepted concrete topped XPS insulation panels.
 - 2) pavers placed on
 - 1) purpose-made pedestals or rubber pads (slip sheets under pedestals may be necessary to prevent membrane abrasion).
 - 2) drainage mats.
 - 3) XPS insulation panels with drainage grooves or channels.
 - 3) proprietary walkway membranes installed in segments.
 - 4) A proprietary coating.

See also **1.6 RoofStar Guarantee: Coverage and Limitations**.

- 7) **Fall protection warning zones** (see [WorkSafeBC Regulations](#) and related materials) **may be designed using**
 - 1) **a proprietary self-adhering tape.**
 - 2) **a proprietary coating.**
- 8) Installed membranes must be protected from damage caused by work performed concurrently or subsequently by other trades. The *Design Authority* is strongly urged to direct the work of other trades through specific, explicit directives in the design specifications.

9.2 Materials

See [Single-ply Waterproofing Roof Membranes](#) accepted for **RoofStar Guaranteed** roof systems. See also **Part 3 SECURING the ROOF ASSEMBLY** for special requirements concerning *Waterproofing (Membrane) Roof Systems*.

9.2.1 Composition, Thickness and Selection

- 1) Membranes must be selected from the Accepted Materials, and each membrane must conform the minimum requirements outlined in **Table 9.1** and **Table 9.2**.

- Liquid membranes must be reinforced and accepted for use both by the single ply manufacturer and by the manufacturer of the liquid membrane.

Table 9.1 Single-ply Membranes: RoofStar 5 and 10-Year Guarantee

All thicknesses shown are in mm (mils)

Membrane Type	Conventionally Insulated or Uninsulated Waterproofing Systems (Roofs)					Gutters	Roof as a Platform	Grade-level Waterproofing
	Loose-laid	Mech. Fastened	Self-adhered	Adhered				
				Compact or PMRA	Fleece-backed			
EPDM (reinforced)	1.143 (45)	1.52 (60)	1.52 (60)	1.143 (45)	N/A	1.524 (60)	1.524 (60)	N/A
EPDM (unreinforced)	1.143 (45)	N/A	1.524 (60)	1.143 (45)	2.79 (110)	1.524 (60)	1.524 (60)	N/A
TPO	1.143 (45)	1.143 (45)	1.524 (60)	1.143 (45)	2.79 (110)	1.524 (60)	1.524 (60)	N/A
PVC	1.27 (50)	1.27 (50)	N/A	1.27 (50)	2.67 (105)	1.524 (60)	1.524 (60)	1.52 (60)

Table 9.2 Single-ply Membranes: RoofStar 15-Year Guarantee

All thicknesses shown are in mm (mils)

Membrane Type	Conventionally Insulated or Uninsulated Waterproofing Systems (Roofs)					Gutters	Roof as a Platform	Grade-level Waterproofing
	Loose-laid	Mech. Fastened	Self-adhered	Adhered				
				Compact or PMRA	Fleece-backed			
EPDM (reinforced)	N/A	1.52 (60)	1.52 (60)	1.52 (60)	N/A	2.032 (80)	2.032 (80)	N/A
EPDM (unreinforced)	N/A	N/A	1.524 (60)	1.52 (60)	2.79 (110)	2.032 (80)	2.032 (80)	N/A
TPO	N/A	1.52 (60)	1.524 (60)	1.52 (60)	2.79 (110)	2.286 (90)	2.286 (90)	N/A
PVC	N/A	1.52 (60)	N/A	1.52 (60)	2.67 (105)	2.286 (90)	2.286 (90)	N/A

9.2.2 Fasteners and Adhesives

- Unless otherwise specified in these Standards, fasteners used to secure the membrane must be the fasteners specified by the membrane manufacturer or, when a fastener is not specified, a #14 screw-type fastener or impact-driven fastener compatible with all secured materials.

See **3.2.3 Fasteners and Adhesives** for attachment requirements.

- Only Type 3 or 4 oxidized asphalt or Type 3 or 4 SEBS modified asphalt is permitted for installation of hot-applied membranes.

9.2.3 Accessories

- All materials, including but not limited to securement strips, primers, adhesives, sealants, cleaners and membrane flashings, that comprise the *roof system* must be supplied or accepted by the membrane manufacturer.

9.3 Application

9.3.1 General

9.3.1.1 RoofStar 15-Year Guarantee

- Refer to **1.3.1 RoofStar 15-Year Guarantee** for general requirements, to qualify the *Project* for a **RoofStar 15-year Guarantee**.
- T-joints must be covered with a proprietary cover sealed along all edges with the membrane sealant, or with a field-fabricated cover fit to extend past the intersecting membranes 100 mm (4"), using unreinforced PVC covers.

9.3.1.2 All Projects

- 1) Membranes must be installed according to the manufacturer's published instructions, details and installation techniques unless exceeded by these **Standards**.
- 2) An intermediate separation layer must be installed between
 - 1) PVC membranes and foam plastic insulation materials (because of chemical incompatibility).
 - 2) all fully adhered membranes and rough deck surfaces in a *Protected Membrane Roof System*.
- 3) Membranes must be
 - 1) unrolled and allowed to 'relax' for at least thirty (30) minutes prior to installation.
 - 2) conditioned in keeping with the membrane manufacturer's guidelines for storage and cold weather application.
- 4) *Conventionally Insulated Systems* must be
 - 1) temporarily and continuously sealed, at the end of a day, or when installation must be stopped because of circumstance (such as inclement weather), to envelope any other components enclosed below the membrane *system*.
 - 2) positively lapped, wherever possible.
- 5) All membranes must be mechanically secured
 - 1) around the perimeter.
 - 2) at a slope change greater than 2:12.
 - 3) around all curbs.
 - 4) at all drains and protrusions (mechanically fastened *systems* only).

Securement spacing must conform to the membrane manufacturer's published requirements, unless exceeded by these Standards. See also **Part 3 SECURING the ROOF ASSEMBLY**.

- 6) Perform field test welds on a daily basis, prior to welding, and thereafter at 2-hour intervals. When welding commences before the field Observer can verify the field test weld, a cut test may be required.
- 7) All field membrane seams must be
 - 1) clean and dry.
 - 2) fully rolled.
 - 3) free of fish-mouths.
 - 4) installed so that any membrane laps are located at least 900 mm (36") from the centre of any roof field drain, except where drain sumps are employed.
 - 5) installed so that they overlap adjacent membranes (side laps) at least 150 mm (6") where in-seam fasteners are used, extending beyond the fastener plate by at least 50 mm (2").
 - 6) sealed
 - 1) at least 38 mm (1 ½") wide using a robotic welder, and seams probed to verify a consistent bond.
 - 2) at least 50 mm (2") wide using a hand-held welder, and seams probed to verify a consistent bond.
 - 3) with visible, continuous edge sealant (when required by the membrane manufacturer).
 - 7) covered at T-joints with a proprietary cover sealed along all edges with the membrane sealant, or with a field-fabricated cover fit to extend past the intersecting membranes 50 mm (2"), using unreinforced PVC covers.
- 8) All installed membranes must be protected from
 - 1) damage by traffic and other trades.
 - 2) splashed or dripped primer. This standard also applies to work by other trades, who may use primers for self-adhering membranes typically installed on *walls* or around doors, windows or other *wall* penetrations.

9.3.2 Material Storage and Handling

- 1) All uninstalled materials must be
 - 1) protected from weather.
 - 2) stacked above ground or the roof surface in packaging provided.
 - 3) approved or recommended by the manufacturer.

9.3.3 Mechanically Attached Membranes

- 1) Whenever possible, orient mechanically fastened membranes perpendicular to steel *deck* flutes in order to distribute fasteners across the *deck*.
- 2) To secure the membrane, use fasteners and stress plates, or a proprietary securement bar, that are
 - 1) specifically designed for the application of the specified and installed membrane, or are
 - 2) listed in the *Tested Assembly* report as an acceptable alternative (Substitutions, without the written consent of the primary membrane manufacturer, are not permitted and may void the **RoofStar Guarantee**).
- 3) Unless otherwise listed in the assembly components of a *Tested Assembly*, membranes shall be fastened with self-drilling purpose-made #14 screws having a deep-recessed head.

9.3.4 Loose-laid Ballasted Membranes

- 1) Loose-laid membranes held in place with gravel ballast must
 - 1) meet the thickness requirements in **9.2.1 Composition, Thickness and Selection**.
 - 2) be installed
 - 1) according to the membrane manufacturer's published instructions.
 - 2) over smooth, flat and clean substrates that are free of protrusions and foreign matter.
 - 3) not be installed over mechanically fastened substrates or hard-surfaced overlays.

9.3.5 Adhered Membranes

9.3.5.1 General

- 1) Fully adhered single-ply membranes must not be installed directly to a supporting wood or concrete *deck* structure but may be applied over a RoofStar-accepted *deck overlay* suitably fastened to the *deck*.

9.3.5.2 Self-adhered and Adhesive-applied Membranes

- 1) Self-adhering membranes must be
 - 1) applied to a suitable, clean, dry substrate and in keeping with the manufacturer's published instructions.
 - 2) installed only when the ambient air temperature meets or exceeds the temperature permitted by the manufacturer.
 - 3) installed over a primed membrane lap, when required by the manufacturer.
 - 4) fully rolled or broomed, as required by the membrane manufacturer, to ensure even, full contact with the substrate. **Air bubbles should be avoided and must fall within the permissible tolerances provided by the membrane manufacturer or the *Tested Assembly*.**
- 2) Adhesive-applied membranes must be
 - 1) applied to a suitable, clean, dry substrate and in keeping with the manufacturer's published instructions.
 - 2) installed only when the ambient air temperature meets or exceeds the temperature permitted by the manufacturer.
 - 3) applied with bonding adhesive evenly applied to both the substrate and the membrane, and allowed to dry to the touch, or as otherwise specified by the membrane manufacturer.
 - 4) fully rolled or broomed, as required by the membrane manufacturer, to ensure even, full contact with the substrate. **Air bubbles should be avoided and must fall within the permissible tolerances provided by the membrane manufacturer or the *Tested Assembly*.**

- 3) End laps must be sealed in keeping with the membrane manufacturer's published instructions. When a cover strip is required, refer to the Standards in **9.3.1.2 All Projects**.

9.3.5.3 Hot Asphalt-adhered Membranes

- 1) Only fleece-backed membranes may be installed with hot asphalt.
- 2) All concrete *decks* to receive adhered membranes must be primed with the membrane manufacturer's asphaltic primer.
- 3) Asphalt
 - 1) temperature must be at least 205°C (400°F) but must conform to the membrane manufacturer's requirements.
 - 2) *should be mopped no more than 1 m (3') ahead of the roll.*
 - 3) application rates may vary depending upon the substrate, and therefore the rates must follow the manufacturer's published instructions.

9.3.6 [Not Used]

9.3.7 Membrane Walkways and Warning Zones

See also **Part 14 The ROOF as a PLATFORM** for design, material and installation requirements when using elevated pavers or other walkway materials.

- 1) When pavers are used as the walkway material they must be
 - 1) spaced no closer than 3mm (1/8").
 - 2) supported by non-abrasive pads or proprietary pedestals providing a minimum of 12.7 mm (1/2") of vertical separation layer for airflow and leveling (slip sheets under pedestals may be necessary to prevent membrane abrasion).
 - 3) secured against movement by wind, as required.
- 2) Self-adhering tapes that are applied on top of the primary membrane, to serve a warning zone, must be
 - 1) acceptable to the manufacturer of the primary membrane.
 - 2) installed
 - 1) on a clean, dry membrane.
 - 2) according to the published instructions of all manufacturers concerned.
- 3) Tapes used to demarcate zones on the roof are excluded from coverage under the ***RoofStar Guarantee***. Refer to **1.6 RoofStar Guarantee: Coverage and Limitations**.

10 PERIMETERS and WALLS

10.1 General

10.1.1 Definitions

Refer to the [Glossary](#) for further definitions of key terms used in this *Manual*.

Low Door

means a door with a rough opening less than 200 mm (8") above the *Finished Waterproofing System*, but no less than 100 mm (4") above the roof membrane.

Standard Door

means a door located at least 200 mm (8") above the *Finished Waterproofing System*.

Tall Parapet

means a parapet taller than 600 mm (24").

10.1.2 Design

10.1.2.1 RoofStar 15-Year Guarantee

- 1) Refer to **1.3.1 RoofStar 15-Year Guarantee** for general requirements, to qualify the *Project* for a **RoofStar 15-year Guarantee**.

10.1.2.2 All Projects

- 1) The *Design Authority* is responsible to specify the sequencing of construction so that intersecting *systems* are positively connected. See **10.3.2 Sequencing**.
- 2) All membranes must be fully adhered to vertical substrates, and when the membrane terminates on the vertical face of the *wall* or parapet, it must be mechanically secured at the membrane termination.
- 3) When a roof *Waterproofing System* transitions to
 - 1) a high *wall*, additional mechanical securement may be required by the manufacturer.
 - 2) a sloped or vertical plane, the transition may be made with a continuous membrane from the field, or with a separate membrane flashing. In either case, the membrane must be
 - 1) fully adhered.
 - 2) mechanically secured at the upper termination.
 - 3) lapped onto the field membrane in keeping with the membrane manufacturer's published specifications, or as otherwise stated in these Standards.
- 4) Except where low parapets, metal fascia edge flashings and low door sills or window details are incorporated in the design (see also **10.3.7 Door Openings**), all membrane flashing (stripping) must extend vertically on perimeter surfaces at least 200 mm (8") above the roof field membrane, to permit a proper watertight seal. Where pavers, ballast, growing media or any other type of *Roof Coverings* are designed for placement on top of the field membrane, membrane flashing must be carried vertically past the top surface of the covering (the *Finished Waterproofing System*) at least 200 mm (8").
- 5) Regardless of parapet height, membrane flashing must be carried up the inside face of the parapet *walls* no less than 200 mm (8") above the *Finished Waterproofing System*.
- 6) Tall parapets should be designed with consideration given to ventilation.
- 7) Parapets are not required at the edge of a *Conventionally Insulated System* that does not support overburdens, but when they are specified and constructed they must be no less than 125 mm (5") in height, measured from the finished roof surface to the inside top edge of the parapet, in order to facilitate proper metal cap flashing securement. See also **13.3.4 Cap, Counter and Base Flashings**.
- 8) When a roof is designed to support *Overburden* or is held in place with ballast, the roof must be designed to retain the *Overburden* or ballast against wind scouring, but in any event must be designed with parapets at least 200 mm (8") in height when measured from the top surface of the overburden or ballast. See also **Part 3 SECURING the ROOF ASSEMBLY**.

- 9) Mechanical fasteners used to secure a metal flashing or *wall* finish must be installed at least 89 mm (3 ½") above the finished roof surface.
- 10) When a *wall* or parapet is faced with multi-wythe masonry or composite panels, and the membrane flashing must be installed over the face of the *wall* or parapet, the through-*wall* flashing that separates wythes or courses of panels must be
 - 1) supplied and installed by others.
 - 2) situated at the next course above the terminated edge of the membrane flashing and any metal roof flashings.

Refer to current seismic codes for suitability.

In the alternative to the above, the entire inside face of a parapet *wall* must be completely flashed or cladded.

- 11) When a metal edge termination detail is used, the edge must be fully blocked to support the metal and membrane edges.
- 12) Cant edges are not required or recommended, since single-ply membranes are manufactured to transition from horizontal to vertical planes without the assistance of a cant. Cant edges on existing roofs may be left in place, at the discretion of the *Design Authority*.
- 13) When a roof *Waterproofing System* transitions
 - 1) down a slope onto a lower *Water-shedding System*, the *Waterproofing System* membrane must positively lap the *Water-shedding System* by no less than 50 mm (2").
 - 2) up a slope and beneath a *Water-shedding System*,
 - 1) the *Waterproofing System* membrane must extend up the *Water-shedding* slope at least
 - 1) 150 mm (6"), or
 - 2) 300 mm (12") in regions with typical heavy snow.
 - 2) fasteners for the *Water-shedding System* must be at least 89 mm (3 ½") above the finished surface of the *Waterproofing System* (when measured vertically).
 - 3) the *Water-shedding System* materials must overlap the *Waterproofing System* by at least 150 mm (6").
 - 3) with a *wall*, *wall* membranes and finishes must positively lap membrane flashing by at least 75 mm (3").
- 14) Where a roof allows water to freely drain off the edge, a cricket or diverter should be installed at the roof edge where the roof adjoins a *wall*, to prevent water intrusion behind *wall* finishes.

10.2 Materials

10.2.1 Membranes

- 1) Membranes used to flash (strip) *walls*, parapets or other edges may be the same as the membrane used on the field, but in any event must conform to the membrane requirements found in **9.2.1 Composition, Thickness and Selection**.
- 2) When a *Waterproofing System* transitions with a *Water-shedding System*, the intersecting materials must be compatible with each other.
- 3) When cant edges are specified, they must be fabricated from wood.

10.2.2 Fasteners

- 1) Fasteners used to secure the upper termination of membranes must be the fasteners specified by the membrane manufacturer or, when a fastener is not specified, a #12 screw-type fastener or impact-driven fastener compatible with all secured materials.

10.2.3 Metal Flashings

- 1) *Linear Metal Flashings* incorporated into roof perimeters and *walls* must conform to the materials and fabrication standards found in **13.2 Materials**.

10.3 Application

10.3.1 General

10.3.1.1 RoofStar 15-Year Guarantee

- 1) Refer to **1.3.1 RoofStar 15-Year Guarantee** for general requirements, to qualify the *Project* for a **RoofStar 15-year Guarantee**.
- 2) EPDM membrane system Projects only: all outside corners must be double-wrapped using semi-cured membrane, installed according to the membrane manufacturer's published details and written requirements.

10.3.1.2 All Projects

- 1) All installed membranes must be protected from splashed or dripped primer. This standard also applies to work by other trades, who may use primers for self-adhering membranes typically installed on *walls* or around doors, windows or other *wall* penetrations.
- 2) Membrane flashing plies must be installed according to the manufacturer's published instructions, but in any event must be
 - 1) installed from the low point of the roof (for positive laps toward the drain).
 - 2) wrapped over the top of the parapet or roof edge and down the outside face by at least 50 mm (2").
 - 3) extend
 - 1) onto the field of the roof, as required by the membrane manufacturer, when separate membrane flashing plies are used.
 - 2) up a vertical surface at least 200 mm (8") above the roof field membrane or *roof covering*, to permit a proper watertight seal. Where pavers, ballast, growing media or any other type of **Roof Coverings** are installed on top of the field membrane, membrane flashing must be carried vertically past the top surface of the covering (the *Finished Waterproofing System*) at least 200 mm (8").
 - 4) installed without fish-mouths or wrinkles, hand-rolled with a membrane manufacturer's accepted roller and fully bonded to an acceptable, prepared substrate.
 - 5) reinforced at all inside and outside corners with membrane corner details or seam transition covers
 - 1) wherever the membrane flashing changes planes (vertical to horizontal, for example).
 - 2) installed in accordance with the manufacturer's published instructions.
 - 6) mechanically secured at the termination of the membrane flashing and protected with an acceptable *Linear Metal Flashing*.
 - 7) finished and sealed before the end of the working day.
 - 8) correctly lapped with any *wall* membranes or finishes by at least
 - 1) 75 mm (3") when installed underneath *wall* materials.
 - 2) 50 mm (2") when installed over *wall* materials.
- 3) All membranes or membrane flashing terminating on any vertical surface must be secured to the vertical substrate by the *Contractor*. Exposed membrane edges must also be protected from water intrusion. This must be accomplished using one of the following options, ranked according to the maintenance they require (low to high):
 - 1) Adhere the roof membrane to the *wall* surface, and
 - 1) protect the exposed membrane edge with overlapping *wall* membranes and exterior sheathing (**Figure 10.3.1a**).
 - 2) cover the exposed membrane edge with a secondary, fleece-reinforced 2-component liquid membrane flashing (use only with a RoofStar-accepted liquid flashing materials specifically acceptable to the membrane manufacturer) (**Figure 10.3.1b**).
 - 2) Mechanically secure the membrane to the *wall* with a proprietary termination bar fastened no more than 300 mm (12") O.C.; caulk the upper edge of the termination bar and cover the bar with a cut

reglet flashing sealed inside the reglet cut with an acceptable sealant (see **13.2.4 Sealants**) (**Figure 10.3.1c**).

- 3) Mechanically secure the membrane to the *wall* with a proprietary termination bar fastened no more than 300 mm (12") O.C.; caulk the upper edge of the termination bar and cover the bar with a secondary metal surface reglet flashing that is separately attached to the *wall* (no more than 300 mm (12") O.C.) and sealed along the upper edge with an acceptable sealant (see **13.2.4 Sealants**) (**Figure 10.3.1d**).
- 4) Mechanically secure the membrane to the *wall*; surface-mount a reglet flashing above the terminated membrane and seal the metal flashing along the upper edge with an acceptable sealant; install a second surface-mounted reglet flashing and seal it along the upper edge with an acceptable sealant (see **13.2.4 Sealants**) (**Figure 10.3.1e**).

See also **13.3.5 Cap, Counter and Base Flashings** for *Linear Metal Flashing* requirements.

- 4) When the roof membrane is mechanically secured with a termination bar or a metal flashing, fasteners must be spaced no more than 300 mm (12") O.C. When closer spacing is required by the membrane manufacturer, the *wall* must be constructed or modified to facilitate solid fastener securement.
- 5) When a second *Linear Metal Flashing* is installed to protect a termination bar or flashing used to secure the membrane, it may be fastened no more than 600 mm (24") O.C. provided the metal flashing maintains continuous contact with the substrate. See also **13.3.1 General** (Application).
- 6) Membranes that intersect with *Water-shedding Systems* must be installed in keeping with **10.3.5.3**.
- 7) Membranes on parapets that intersect with a higher *wall* must be sealed with a membrane saddle formed to protect the inside and outside corners.

10.3.2 Sequencing

- 1) *Projects* must follow proper sequencing. This means that materials must be installed so that they interface with other materials, *systems* or assemblies, including those installed by other trades, in "shingle fashion" by positively overlapping them below or above. Occasionally, the coordination with other trades requires some adaptation to this standard. When that is the case, any variance to proper detail sequencing must be approved by the *Design Authority* in writing.

10.3.3 [Not Used]

10.3.4 Membranes

10.3.4.1 [Not Used]

10.3.4.2 Self-adhered

- 1) Self-adhered membranes must be installed on a clean, uncontaminated surface. Dirty or contaminated surfaces must be covered with
 - 1) plywood sheathing with a minimum nominal thickness of 9.5 mm (3/8").
 - 2) a *wall* overlay.

10.3.4.3 Adhesive and Hot Asphalt-adhered Membranes

- 1) Adhered membranes must be installed on a clean, uncontaminated surface. Dirty or contaminated surfaces must be covered with
 - 1) plywood sheathing with a minimum nominal thickness of 9.5 mm (3/8").
 - 2) a *wall* overlay.
- 2) Hot-asphalt adhered membranes must be installed according to the membrane manufacturers' installation specifications.

10.3.5 Perimeters and *Walks*

10.3.5.1 [NOT USED]

10.3.5.2 Metal Edge Terminations

Membrane roof assemblies may be terminated at the roof edge, flush with the roof surface, using a metal edge flashing. Metal edge flashings must be installed to the following standards:

10.3.5.1 [NOT USED]

10.3.5.2 Metal Edge Terminations

Membrane roof *Waterproofing Systems* may be terminated at the roof edge, flush with the roof surface, using a linear metal edge flashing. Metal edge flashings must be installed to the following standards:

- 1) *Conventionally Insulated Systems* terminating on the horizontal plane with a metal edge flashing must abut blocking at the roof edge.
- 2) Metal edge flashings must be
 - 1) acceptable to the membrane manufacturer.
 - 2) installed over a separation layer of membrane flashing that extends onto the roof field at least 50 mm (2") and down the outside face of the roof edge at least 50 mm (2").
 - 3) fastened to the roof surface with mechanical fasteners
 - 1) placed at least 50 mm (2") away from the outside edge.
 - 2) spaced 200 mm (8") O.C. in offsetting rows.
 - 4) joined to each other with lap joints measuring at least 100 mm (4") and sealed with caulking (see the requirements in **13.3.4 Seams**).
 - 5) sealed to the membrane which must extend
 - 1) at least 100 mm (4") onto the metal flashing, and at least 50 mm (2") past the fasteners.
 - 2) at least 100 mm (4") onto the field membrane, when utilizing a cover strip.
- 3) When a metal diverter flashing is required, it must be fabricated like a metal edge flashing, and must be secured and sealed to the primary membrane with membrane flashing (stripping).

10.3.5.3 [NOT USED]

10.3.5.4 Transitions with *Water-shedding Systems*

- 1) Where two roof systems intersect, materials must be compatible with each other, or must be separated from contact by an intermediate separation layer.
- 2) When a *Waterproofing System* transitions
 - 1) down a slope onto a lower *Water-shedding System*, the waterproofing membrane must lap over the *Water-shedding System* by no less than 50 mm (2").
 - 2) up a slope and beneath a *Water-shedding System*,
 - 1) the field membrane or membrane flashing must extend up the *Water-shedding System* slope at least
 - 1) 200 mm (8"), plus 75 mm (3") for the overlap by the *Water-shedding System*, when measured vertically from the water plane, or 150 mm (6") when measured vertically from the maximum water level.
 - 2) 300 mm (12") plus 75 mm (3") for the overlap by the *Water-shedding System*, when measured vertically from the water plane or maximum water level, in regions with typical heavy snow.
 - 2) the termination of the membrane on the slope must be mechanically secured, separately from the *Water-shedding System*.
 - 3) fasteners for the *Water-shedding System* must be at least 200 mm (8") above the *Finished Waterproofing System* (when measured vertically from the water plane), or 300 mm (12") for regions with heavy snow.

- 4) the *Water-shedding System* materials must overlap the *Waterproofing System* by at least 150 mm (6").
- 3) with a *wall, wall* membranes and finishes must positively lap membrane flashing by at least 75 mm (3").

10.3.6 Expansion and Control Joints

See **2.4 Expansion Joints** and **2.5 Control Joints** above. Membrane application must conform to the general requirements outlined in **10.1 General**.

- 1) Expansion joints constructed as a raised divider must have a sloped top surface and must extend in height above the *Finished Waterproofing System* no less than 200 mm (8"). The minimum height of the expansion joint may be reduced to 125 mm (5") if the primary roof membrane flashing is fully supported and sealed over the top.
- 2) Proprietary elastomeric expansion joint systems, manufactured with an EPDM-based core and flanges that can be fully bonded to the primary membrane, are acceptable for use in *Waterproofing Systems* when the systems are located a minimum of 200mm (8") above the *Finished Waterproofing System* and are completely sheathed (covered) with sloped *Linear Metal Flashing*. Such joints must be
 - 1) accepted for use in the **RoofStar Guarantee Program**.
 - 2) compatible with the roof membrane and acceptable to the membrane manufacturer.
 - 3) designed and manufactured to accommodate building movements of at least 500% elongation at -40°C (-40°F) across its length and at all vulcanized points.
 - 4) factory-fabricated by means of vulcanization.
 - 5) manufactured as one piece, complete with all joints, details and connections.
 - 6) bonded with the primary membrane in a manner acceptable to the manufacturers of both the expansion joint and the membrane to which it will be bonded.
- 3) Field splicing of proprietary elastomeric expansion joints is permitted only when made with a machine acceptable to the expansion joint manufacturer. All other field splices are not permitted.

10.3.7 Door Openings

- 1) *Standard door* openings must be flashed with membrane, reinforced with gussets at the sill corners, carried vertically on all surfaces of the door sill opening at least 100 mm (4").
- 2) **The RGC recommends against low door openings because of their propensity to leak.** Nevertheless, when a *low door* opening is specified to comply with building codes, it must be waterproofed in keeping with the following standards:
 - 1) The opening at the curb must be waterproofed before the door frame and sill is installed, by one of the following accepted methods:
 - 1) Sheet membrane flashing
 - 1) reinforced with gussets at the sill corners.
 - 2) carried vertically on all surfaces of the door sill opening at least 100 mm (4").
 - 3) terminated on a mechanically attached water-stop flashing sized to underneath the door sill and sealed to the opening with membrane flashing.
 - 2) A metal water stop flashing, fabricated with folded, welded or soldered corners and mechanically attached to inside of door sill opening. The pan must be sealed to the door curb and opening with membrane flashing.
 - 3) Reinforced liquid membrane flashing applied in keeping with the requirements for sheet membrane flashings above.
 - 2) The roof must be sloped away from the door opening.
 - 3) Overflow drains must be
 - 1) installed on the same roof area and located at least 25 mm (1") below the door sill.
 - 2) capable of flow rates equivalent to or greater than those of the primary roof drains for the roof areas adjacent to the door opening (see also **11.3.2.5 Scuppers and Overflows**).

- 4) When the building interior transitions to a patio or occupied roof surface through a flush door opening, the walking surface of the patio or roof must protect the roof membrane from damage and provide a drainage space below the walking surface measuring at least 12.7 mm (1/2"). Alternatively, pea gravel installed on a drainage board may be used.
- 5) **Overhangs above the door are recommended wherever practical, to minimize water intrusion that occurs from wind-driven rain or from snow accumulation.**

10.3.8 [Not Used]

11 DRAINAGE and PENETRATIONS

11.1 General

This section pertains to the waterproofing of roof penetrations, curbs, sleepers, drains and any other "details", in order to qualify for a **RoofStar Guarantee**.

11.1.1 Definitions

Refer to the [Glossary](#) for further definitions of key terms used in this *Manual*.

Drain Leader

means "a pipe that is installed to carry *storm water* from a roof to a *storm building drain* or *sewer* or other place of disposal" (*British Columbia Plumbing Code, Division A, Part 1*).

Flange-style Drain

means a *primary roof drain* with a flat, broad flange fabricated from the same material as the bowl and leader, and encompassing the perimeter of the drain bowl or, in the case of flat drains, the drain leader. Flange-style drains are not cast but rather are manufactured from components that are hot-welded. Flange-style drains are typically secured to the roof with mechanical fasteners.

Overflow Drain ("Overflow")

means a *secondary roof drain* that serves as a safeguard when roof drains fail. An overflow may be located in the roof field (for example, as a secondary drain) or at the perimeter of the roof.

Primary Roof Drain

means the primary means of draining water from the roof.

Roof Drain

means "A fitting or device that is installed in the roof to permit storm water to discharge into a *leader*." (*British Columbia Plumbing Code, Division A, Part 1*).

Scupper Drain ("Scupper")

means an open or closed roof drain that conveys water laterally from one roof area to another, or from the roof directly to the exterior of the building.

Secondary Roof Drain

means an alternate drainage path in the event of large rain events or significant snow melt, typically situated at a higher elevation than a primary roof drain.

11.1.2 Design (Drainage)

11.1.2.1 RoofStar 15-Year Guarantee

- 1) Refer to **1.3.1 RoofStar 15-Year Guarantee** for general requirements, to qualify the *Project* for a **RoofStar 15-year Guarantee**.
- 2) All roof areas must be designed with *overflow drains* that are properly sized and spaced, in keeping with the building and plumbing codes having jurisdiction.
- 3) Only drains and *overflows* equipped with clamping rings, to secure roofing membranes, qualify for a **RoofStar 15-Year RoofStar Guarantee**. In the alternative, and when permitted by the membrane manufacturer, a reinforced 2-component liquid membrane flashing may be used to terminate membranes at the drains. Application of this liquid membrane flashing must be in keeping with the Standards in **11.3.3.3 Liquid Membrane Flashing**.

11.1.2.2 All *Projects*

- 1) With the exception of *overflows*, *scupper drains* and membrane gutters, roof drains and penetration flashings for new construction *Projects* must be located at least 300 mm (12") away from any adjacent drain, penetration, upstand, edge or wall. The separation space is measured between openings, excluding the flange.

- 2) When existing roof drain and penetration locations do not comply with the Standards above, a Variance must be requested from the **RoofStar Guarantee Program** and accompanied by plan and detail drawings to show how the **Guarantee Standards** will be met by the design and construction.
- 3) Only cast-iron roof drains, and existing external couplers used to connect drains to leaders, may be re-used for roof replacement *Projects*. All flange-style drains, *scuppers* and *overflows*, together with internal drain-to-pipe compression seals, and seals exposed to water or ultraviolet light, must be replaced.
- 4) All penetration flashings must be replaced in a roof replacement *Project*.
- 5) The *Design Authority* is responsible for the design of roof drainage. The size (flow rate) of roof drains and overflows should be determined through the *British Columbia Building Code* and *British Columbia Plumbing Code*, with attention given to both average and large rainfall events. For rainfall capacities, refer to the *British Columbia Building Code, Div. B, Appendix C, Table C-2* which lists rainfall loads using specific reference locations throughout the province. **The RoofStar Guarantee Program recommends that various disciplines, including but not limited to mechanical (plumbing) and structural engineers, coordinate calculations to ensure proper flow rates, head pressure and structural supports, in anticipation of significant, short-duration rain events. Consideration should be given to the following elements (without limitation):**
 - 1) **Roof slope – more slope theoretically increases drainage and lessens live loading from rainfall** (see also **2.2 Roof Slope**).
 - 2) **Rainfall rates for primary and overflow drainage.**
 - 3) **Primary and overflow drain capacities.**
 - 4) **Hydraulic head (pressure).**
- 6) Roof drains must not be used as a conduit for other services, such as electrical. All other services must be designed to utilize separate penetration points with purpose-made penetration flashings and Guarantee-compliant detailing.
- 7) Roofs may drain off a roof edge or by means of internal plumbing. Both are permissible under the **RoofStar Guarantee Program**.
- 8) When a roof is designed to drain off an edge, water may drain freely or be collected by means of an external or built-in gutter (**12.2 Built-in Membrane Gutters**) and drained onto a lower roof assembly. The membrane on the lower roof must be protected from abrasion with splash pads.
- 9) When roofs are designed to drain through internal plumbing, the following standards, guiding principles and recommendations apply.
 - 1) **Drain sumps should be incorporated into a roof design whenever possible, to increase head pressure above primary roof drains. Drain sumps should be designed at least 1m x 1m (39" x 39") in size. The depth of a sump is a function of insulation thickness (see 7.1.2.2 (10)). Sumps designed with sloped insulation are strongly recommended.**
 - 2) **Drain sump durability may be enhanced by specifying additional reinforcement around the perimeter, using a reinforced 2-part liquid membrane.**
 - 3) **New and existing buildings should incorporate overflows to handle large rain events.** The primary function of an *overflow* is to keep a roof from collapsing when *primary roof drains* are plugged or cannot drain heavy rainfall. Where no *overflows* are specified, the building structure should be designed to carry the total load of water collected on the roof, in the event of *primary roof drain* failure (see *British Columbia Building Code*).
 - 4) When *overflows* are specified, they must be
 - 1) located
 - 1) no higher than 100 mm (4") above drain elevations.
 - 2) so that they visibly discharge storm water.
 - 2) designed with an opening sufficient in size to equal or exceed the rate of rainfall.
 - 3) designed as open-wall *scuppers* for parapets measuring 150 mm (6") or less in height.
 - 4) designed around the principles of a through-wall scupper, for parapets higher than 150 mm (6").

- 5) *Overflows* must incorporate a continuous flange surrounding the drain opening, measuring at least 100 mm (4") in width, and may be manufactured from ferrous metals, subject to the material standards for metal found in this *Manual*.
- 6) *Overflows* are required for *low door* or low window details. In these applications, the *overflow* must be installed at least 1" lower than the lowest elevation of the door or window opening.
- 7) A *scupper drain* may serve either as a primary roof drain or as a secondary drain.
- 10) If a flow restrictor is present in an existing cast drain leader, the restrictor should be reinstalled.
- 11) Drain extensions for cast-iron roof drains should be avoided, since the connection with the cast drain is not sealed; the result is a leak into the roof system.
- 1) Roofs that support *Overburden* or are secured with ballast must be designed to incorporate a ballast guard that surrounds the drain and promotes water flow.

11.1.3 Design (Curbs and Penetrations)

11.1.3.1 RoofStar 15-Year Guarantee

- 1) Refer to **1.3.1 RoofStar 15-Year Guarantee** for general requirements, to qualify the *Project* for a **RoofStar 15-year Guarantee**.
- 2) When a roof is replaced, all penetration flashings that do not utilize a fitted cap must be installed with clamped double storm collars that are fully sealed around the upper edge. For roofs on newly constructed buildings, the *Contractor* is responsible to supply and install a second storm collar around the penetration (the first collar is typically supplied and installed by others).
- 3) All electrical, gas and other services that penetrate the *roof system* must be protected against water intrusion with
 - 1) proprietary flashings that are sealed into the *roof system*.
 - 2) *curbs* fitted with a "weather head" hood sealed into the *curb* membrane flashing.
 - 3) sealant pockets (used only where unavoidable) that comply with the **RoofStar 15-year Guarantee Standards** found in **11.3 Application**.
- 2) Penetrations in *Conventionally Insulated Systems* must use either of the following:
 - 1) Non-ferrous flashings.
 - 2) Galvanized, hot-welded flashings and vents (in keeping with the requirements in **11.3.3.1 (10)**), provided the flashings, when used at the water plane, are
 - 1) elevated on *curbs*, or
 - 2) coated with a reinforced catalyzed two-component liquid membrane, or
 - 3) coated with two cured applications of an accepted coating.

11.1.3.2 All Projects

- 1) With the exception of *overflows*, *scupper drains* and membrane gutters, roof drains and penetration flashings for new construction *Projects* must be located at least 300 mm (12") away from any adjacent drain, penetration, upstand, edge or wall. The separation space is measured between openings, excluding the flange.
- 2) When existing roof drain and penetration locations do not comply with the Standards above, a Variance must be requested from the **RoofStar Guarantee Program** and accompanied by plan and detail drawings to show how the **Guarantee Standards** will be met by the design and construction.
- 3) All penetration flashings must be replaced in a roof replacement *Project*.
- 4) Roof openings must be enclosed and sealed
 - 1) with *curbs*.
 - 2) penetration flashings.
- 5) Except where fully enveloped sleepers are incorporated in the design, all membrane flashing (stripping) must extend vertically on perimeter surfaces at least 200 mm (8") above the roof field membrane, to permit a proper watertight seal. Where pavers, ballast, growing media or any other type of *Roof Coverings* are

designed for placement on top of the field membrane, both membrane flashing and purpose-made penetration flashings must be carried vertically past the top surface of the *covering* (the *Finished Waterproofing System*) at least 200 mm (8") (see **11.1.2.1 Drainage**; see also **11.3.2.5 Scuppers and Overflows**).

- 6) *Curbs* must be designed so that they can be secured directly to the *supporting deck* structure, or to intermediate blocking. *Curbs* must not be situated on top of the *roof system*.
- 7) Galvanized flashings and vents
 - 1) are permitted on *Uninsulated Systems* or *Conventionally Insulated Systems*, provided
 - 1) the flashing is field-wrapped with the roof membrane. Non-proprietary membrane-compatible coated flashings are not permissible.
 - 2) the penetration opening does not exceed 0.126 m² (196 in²).
 - 2) are not permitted at the water plane in a *Protected Membrane Roof System* or *Modified Protected Membrane Roof System*. Instead, the penetration must be enclosed by a *curb* measuring at least 200 mm (8") in height above the *Finished Waterproofing System*; the galvanized or welded flashing may then be installed and flashed in on top of the *curb*.
 - 3) larger than 0.126 m² (196 in²) must be enclosed or supported by a *curb*.
- 8) Aluminum or copper flashings for penetrations may be located at the water plane in any assembly type.
- 9) Roof penetration flashings must be
 - 1) suitable for only one penetration.
 - 2) properly fitted to form a seal around the penetration.
- 10) Where a standard flashing is not tall enough to enclose and seal the penetration, the joint between the penetration and the flashing must be sealed with alternative methods.
- 11) Single or multiple penetrations may not be flashed with an open-topped flashing filled with sealant, but must be sealed into the *roof system* with one of the following options:
 - 1) Electrical cable penetrations must utilize a gooseneck-type flashing with a weather hood.
 - 2) Pipe-type penetrations must be sealed with
 - 1) the manufacturer's proprietary rubber-based friction seals, mechanical clamps or gooseneck type design.
 - 2) A 2-part site-fabricated or proprietary flashing with a removable inspection/access cap (see **Construction Detail D1.7.7-2**).
 - 3) roof *curbs* and customized metal hoods.
- 12) Sleepers or equipment pads that are completely sealed (enveloped) must be at least 100 mm (4") in height above the *Finished Waterproofing System*, but when they are capped with a metal flashing they must be at least 125 mm (5") in height. All penetrations through the top surface of a sleeper or equipment pad must be additionally sealed using
 - 1) a compression sealant between the membrane and equipment supports.
 - 2) a universal sealant applied around the edges of equipment supports.
- 13) Housekeeping pads situated on top of the finished roof surface and supporting a combined load less than 90 kg (200 lbs) must be separated from the roof with a bond-breaking layer (i.e. XPS insulation). Housekeeping pads supporting larger loads must conform to the standards for sleepers or equipment pads.
- 14) When mechanical equipment that is ventilated on the roof extracts and discharges grease, chemicals or other contaminants that may adversely impact the roof membrane or other *system* components, the *Design Authority* should specify additional protection measures (for example, grease guards or a reinforced 2-part liquid membrane coating).
- 15) Guardrails should be designed for attachment on vertical surfaces only; attachment of guardrails to a horizontal surface is strongly discouraged.
- 16) Pourable sealant pockets should be used only as a last resort, when other flashing methods are impractical. See also **11.3.3.4 Sealant Pockets** for Application requirements.

11.2 Materials

11.2.1 General

- 1) Only new drains and penetration flashings listed in this *Manual* may be used on a *Project* designed and constructed to qualify for a **RoofStar Guarantee**. Reuse of any existing drain (with the exception of serviceable cast iron drains) or any penetration flashing is prohibited and may void the *Guarantee*. See also **1.6 RoofStar Guarantee: Coverage and Limitations**.
- 2) All proprietary membrane flashing accessories used to flash penetrations must be manufactured and supplied by the manufacturer of the primary roof membrane.

11.2.2 Roof Drains and Scuppers

Roof drains are comprised mainly of two parts: a bowl or flange that is affixed to the roof *deck* with mechanical fasteners or a proprietary clamping mechanism; and an integral drain stem that connects the bowl or flange to the leader. Roof drains are sized according to the diameter of the drain stem. As stated above under Design, the appropriate size and number of roof drains for any given roof area is determined by the relevant building code in force (ref. *British Columbia Plumbing Code, Division B – Part 2; 2.4.10.4 Hydraulic Loads from Roofs or Paved Surfaces*).

Roof drains can be further classified as **internal** or **external**. **Internal roof drains** are connected to leaders located and connected to a storm building drain or sewer inside the exterior surface of a building. **Internal roof drains** may be made of cast iron (secured to the *roof assembly* with clamps) or from copper or aluminum, fashioned from spun components that are welded together and incorporate a flange around the drain bowl. **External roof drains** direct storm water outside the exterior surface of a building. **Scuppers** and **overflow drains** are the common types of **external roof drains** and may connect to leaders or simply drain freely. Any requirements for leaders and connections to leaders may be found in the applicable municipal and provincial building and plumbing codes (ref. *British Columbia Building Code, Division B, 5.6.2.2 Accumulation and Disposal*).

- 1) All flange-style drains must be manufactured with a hot-welded or seamless flange at least 100 mm (4") wide when measured from the outer edge of the drain opening.
- 2) **Cast-iron Roof Drains** must be
 - 1) supplied with a sump receiver and under-deck clamp.
 - 2) installed by the trade supplying the roof drain.
- 3) **Lead flashings**, when specified, must be sized to extend past the drain bowl by at least 150 mm (6"), and must have a weight of at least 15 kg/m² (3 lb/ft²).
- 4) **Internal flange-type roof drains** must be hot-welded at the joints between the bowl/flange and drain stem and shall be constructed of non-ferrous material:
 - 1) Copper drains for internal application shall be formed from a minimum weight of 24 oz. sheet copper (0.55 mm or 0.0216").
 - 2) Aluminum drains for internal application shall be formed from a minimum of 12-gauge material (0.820 mm or 0.0325").
- 5) **External flange-type roof drains** must be hot-welded at the joints between the bowl/flange and drain stem and shall be constructed of non-ferrous material:
 - 1) Copper drains for external application shall be formed from a minimum weight of 16 oz. (0.55 mm or 0.0216").
 - 2) Aluminum drains for external application shall be formed from a minimum of 20-gauge material (0.81 mm or 0.032").
- 6) Only mechanical compression type seals may be used to connect insert-type drains to internal drain leaders.
- 7) **Scupper drains (open or closed)** must be
 - 1) manufactured with welded seams and joints.
 - 2) fabricated from
 - 1) copper with a minimum weight of 16 oz. (0.55 mm or 0.0216").

- 2) aluminum with a minimum thickness of 20-gauge (0.812 mm or 0.032").
 - 3) fabricated with a continuous flange surrounding the drain opening, measuring at least 100 mm (4") in width.
 - 4) designed to extend past the outside face of the *wall*.
- 8) **Closed (boxed) scupper drains** must be
- 1) fabricated from
 - 1) copper with a minimum weight of 16 oz. (0.55 mm or 0.0216").
 - 2) aluminum with a minimum thickness of 20-gauge (0.812 mm or 0.032").
 - 2) fully enclosed on four sides, for through-wall applications.
 - 3) fitted with an *overflow* opening at the outside face
 - 1) equal in capacity to the main drain leader opening.
 - 2) at least 38 mm (1 1/2") lower than the top surface of the *scupper drain*.
 - 4) fabricated with a drip edge at the bottom outside edge of the drain to deflect overflow water away from the building.
- 9) **Overflow drains** must incorporate a continuous flange surrounding the drain opening, measuring at least 100 mm (4") in width, and may be manufactured from ferrous metals, subject to the material standards for metal found in this *Manual*. **Pipe-styled overflow drains** must be welded at the flange.
- 10) All roof drains utilized in a *roof assembly* that includes gravel ballast or growing media (soil) must be supplied with the drain manufacturer's proprietary primary drain strainer and secondary stainless-steel ballast guard. In the absence of a proprietary ballast guard, a custom-fabricated guard may be used provided it meets the following requirements:
- 1) Fabricated from 20-gauge stainless-steel.
 - 2) Incorporates 6 mm (1/4") perforations.
 - 3) Equal to or greater in height than the top of the *Finished Waterproofing System*.

11.2.3 Curbs and Penetration Flashings

- 1) All membrane-flashed roof flashings for cylindrical penetrations must be manufactured with materials and methods that meet or exceed the requirements set out in *CSA B272, Prefabricated Self-Sealing Roof Vent Flashings*. Testing by a qualified third party is required to verify compliance with this standard.
- 2) Notwithstanding the above, all penetration flashings must be
 - 1) watertight and seamless or, in the alternative, fabricated with fully hot-welded joints.
 - 2) at least 8" in height, from the flange to the opening or top of the flashing.
 - 3) fabricated with a hot-welded or seamless flange at least 100 mm (4") wide, around the bottom of the flashing.
 - 4) fabricated with a tightly fitted or mechanically attached settlement cap or lid (if so required).
- 3) Galvanized flashings and vents must
 - 1) meet or exceed the *CSA A93* Standard.
 - 2) be made with material no less than 26 Ga. galvanized steel conforming to the metal standards found in **Part 13 METAL FLASHINGS** of this *Manual*.
 - 3) be field-wrapped with the roof membrane. Non-proprietary membrane-compatible coated flashings are not permissible.
- 4) Single or multiple penetrations may not be flashed with an open-topped flashing filled with sealant, but must be sealed into the roof assembly with one of the following options:
 - 1) Electrical cable penetrations must utilize a gooseneck-type flashing with a weather hood.
 - 2) Pipe-type penetrations must be sealed with
 - 1) the manufacturer's proprietary rubber-based friction seals, mechanical clamps or gooseneck type design.
 - 2) a 2-part site-fabricated or proprietary flashing with a removable inspection/access cap.
 - 3) roof *curbs* and customized metal hoods.

- 5) Penetration flashings should be selected for their ability to inhibit the intrusion of vermin and insects into the roof assembly and building interior.

11.2.4 Fasteners

- 1) Mechanical fasteners used to secure the roof membrane and penetration flashings or related accessories must be
 - 1) properly sized in accordance with *roof system* securement requirements (see **Part 3 SECURING the ROOF ASSEMBLY**).
 - 2) self-drilling purpose-made screws having a deep-recessed head.

11.2.5 Sealants

- 1) Sealants must be manufactured by or acceptable to the membrane manufacturer.
- 2) Compression sealants must be formulated to provide waterproofed seals under compressive loads.

11.3 Application

11.3.1 General

11.3.1.1 RoofStar 15-Year Guarantee

- 1) Refer to **11.1.2.2** and **11.1.3.1** for requirements to qualify for a **RoofStar 15-Year Guarantee**.
- 2) When a roof is replaced, all penetration flashings that do not utilize a fitted cap must be installed with clamped double storm collars that are fully sealed around the upper edge. For roofs on newly constructed buildings, the *Contractor* is responsible to supply and install a second storm collar around the penetration (the first collar is typically supplied and installed by others).
- 3) EPDM membrane system Projects only: all outside corners must be double-wrapped using semi-cured membrane, installed according to the membrane manufacturer's published details and written requirements.
- 4) All electrical, gas and other services that penetrate the roof assembly must be protected against water intrusion with
 - 1) proprietary flashings that are sealed into the *roof system*.
 - 2) curbs fitted with a "weather head" hood sealed into the curb membrane flashing.
 - 3) sealant pockets (used only where unavoidable) that, in addition to the Standards in **11.3.3.4 Sealant Pockets**, are at least 100 mm (4") tall, or elevated the same distance above the water plane, when measured from the water plane to the top of the pocket.
- 5) Penetrations in conventionally insulated roof *systems* must use either of the following:
 - 1) Non-ferrous flashings.
 - 2) Galvanized, hot-welded flashings and vents (in keeping with the requirements in **11.3.3.1(7)**), provided the flashings, when used at the water plane, are
 - 1) elevated on curbs, or
 - 2) coated with a reinforced catalyzed two-component liquid membrane, or
 - 3) coated with two cured applications of an accepted coating.

11.3.1.2 All *Projects*

- 1) With the exception of *overflows*, *scupper drains* and membrane gutters, roof drains and penetration flashings for new construction *Projects* must be located at least 300 mm (12") away from any adjacent drain, penetration, upstand, edge or *wall*. The separation space is measured between openings, excluding the flange.
- 2) Blocking installed to support drains or protrusion flashings (normally the work of other trades) must be sufficiently secured to the supporting *deck* to resist wind uplift loads.
- 3) All membrane flashing must be hand rolled with a membrane manufacturer's accepted roller.

- 4) All inside and outside corners of membrane-flashed penetrations must be reinforced with the membrane manufacturer's proprietary membrane gussets or corners (pre-formed or site-fabricated), measuring at least 150 mm x 150 mm (6" x 6"), unless exceeded by the membrane manufacturer's published requirements.
- 5) All seams, gussets, corners and membrane covers must be properly prepared and sealed at the edges with a membrane-compatible sealant.
- 6) All metal flanged penetrations must be
 - 1) clean and dry.
 - 2) rounded (trimmed) at the corners.
 - 3) separated from wood blocking with a membrane separation sheet.
 - 4) installed in a bed of sealant acceptable to the membrane manufacturer.
 - 5) securely fastened to wood blocking.
- 7) Membrane patches installed over flanged drains or penetration flashings must be
 - 1) of like kind and thickness as the field membrane, unless otherwise specified by a manufacturer's detail.
 - 2) large enough to extend past the flange at least 75 mm (3"), and fully adhered to the field membrane (EPDM only).
 - 3) hot-welded to the field membrane along the outer 50 mm (2") perimeter of the patch and sealed along the edges of the patch with a compatible sealant (TPO and PVC only).
 - 4) extended up any vertical surface at least 200 mm (8") and clamped (where required in these Standards).
 - 5) sealed at all edges with an acceptable sealant.

11.3.2 Roof Drains

11.3.2.1 General

- 1) Drains must be secured to the *supporting deck* structure, or to blocking.
- 2) All insert-type drains shall be connected to internal leaders using only mechanical compression type seals. "O"-rings, mastics and caulking are not acceptable methods for sealing these types of drains to leaders.
- 3) Proprietary water-compression sealant must be used on all drain applications.
- 4) All clamping rings and strainers must be unbroken, properly seated and fully secured.
- 5) When a roof supports *Overburden* or is secured with ballast, drains must be installed together with a surrounding ballast guard that promotes water flow. This requirement is in addition to the requirement for a separation space required for *Vegetated Roof Systems*. See also **14.1.2.2.3 (6)**.
- 6) When a membrane field seam comes within 150 mm (6") of the drain clamping ring or a drain sump, the roof drain or sump must be separately flashed with a target patch
 - 1) symmetrical in size and centred over the drain.
 - 2) cut from the same material as the field membrane.
 - 3) installed before the field membrane, to achieve positive membrane laps.
 - 4) extending past the cut field membrane a sufficient distance for the required seam (see **9.3.1.2 All Projects**).

11.3.2.2 Cast-iron Roof Drains

- 1) When cast-iron roof drains are used, a sump receiver and under-*deck* clamp must be provided and installed by the trade supplying the roof drain.
- 2) Drain extensions for cast-iron roof drains should be avoided.
- 3) Notwithstanding the above, if a flow restrictor is present in an existing cast drain leader, the restrictor should be reinstalled.
- 4) All cast-iron roof drains must be
 - 1) flashed in accordance with the membrane manufacturer's published instructions, or to the standards published in this Part, whichever are greater.
 - 2) new or clean, and the drain and clamping rings must be unbroken.

- 5) Cast-iron drains installed with **continuous field membrane**:
 - 1) The continuity of air and vapour control layers must be maintained, where the controls are specified.
 - 2) All roof system components, including tapered insulation, must be cut to fit closely around the drain bowl and leader.
 - 3) The drain flange must be clean and dry.
 - 4) A membrane-compatible sealant must be applied to the drain flange where it makes contact with the clamping ring.
 - 5) A membrane patch, matching in thickness and composition to the field membrane, must be
 - 1) applied over the drain flange and onto the roof field.
 - 2) cut for the drain opening so that the opening exceeds the size of the drainpipe, but the membrane must extend inside drain bowl at least 12 mm (1/2") past the clamping ring and its attachment points.
 - 3) punched or tightly cut for clamping bolt holes; clamping ring bolts must be snugly threaded through each hole.
 - 4) formed to conform to the contours of the drain bowl.
 - 5) symmetrical and large enough to extend from the clamping ring at least 150 mm (6") to the edge of the finished seam.
 - 6) The clamping ring must be seated and secured, ensuring it is not broken.
 - 7) The drain screen must be securely installed.
- 6) Cast-iron drains installed with **membrane flashing** (target patch):
 - 1) The continuity of air and vapour control layers must be maintained, where the controls are specified.
 - 2) All roof assembly components, including tapered insulation, must be cut to fit closely around the drain bowl and leader.
 - 3) The drain flange must be clean and dry.
 - 4) A membrane-compatible sealant must be applied to the drain flange where it makes contact with the clamping ring.
 - 5) A membrane patch, matching in thickness and composition to the field membrane, must be
 - 1) applied over the drain flange and onto the roof field.
 - 2) cut for the drain opening so that the opening exceeds the size of the drainpipe, but the membrane must extend inside drain bowl at least 12 mm (1/2") past the clamping ring and its attachment points.
 - 3) punched or tightly cut for clamping bolt holes; clamping ring bolts must be snugly threaded through each hole.
 - 4) formed to conform to the contours of the drain bowl.
 - 5) symmetrical and large enough to extend from the clamping ring at least 150 mm (6") to the edge of the finished seam.
 - 6) seamed and sealed with the field membrane in keeping with the standards for seams in **9.3.1.2 All Projects**.
 - 6) The clamping ring must be seated and secured, ensuring it is not broken.
 - 7) The drain screen must be securely installed.

11.3.2.3 Roof Drain Inserts (Replacement Roofing)

- 1) An external coupling is preferable to an internal mechanical compression seal, but when an internal compression seal is used out of necessity, the joint must be properly prepared to ensure the joined surfaces are clean, smooth and uniform. Honing out the cast pipe may be required.
- 2) When a cast-iron roof drain has deteriorated to the extent that it cannot receive a new roof membrane, installation must conform to the membrane manufacturer's published instructions, or to the following standards, whichever are greater:
 - 1) Remove any broken parts and debris.
 - 2) Install the drain insert utilizing a compression seal (see **11.3.2.1 General**).

Page 70 of 95

RoofStar Guarantee Standards

for PVC Membrane Systems

Updated July 2020

© RCABC 2020

No reproduction of these Standards, in whole or in part, is lawful without the expressed permission of the RGC Guarantee Program.

11.3.2.4 [NOT USED]

11.3.2.5 Scuppers and Overflows

- 1) **Open scupper drains** may be constructed to match the height of the parapet or roof edge and must be fully sealed with the field and perimeter membrane flashing.
- 2) When a **through-wall scupper** is specified, only fully enclosed scupper drains (enclosed on all sides and open only at the inflow and outflow ends) may be installed.
- 3) **Overflow drains** and **roof scuppers** that are installed through walls may be installed no closer than 200 mm (8") to
 - 1) a roof drain.
 - 2) any protrusion and its flashing.
- 4) Clamping collars must be securely installed as designed and where specified.

11.3.3 Curbs and Penetration Flashings

11.3.3.1 General

- 1) Roof openings must be enclosed and sealed with either of the following:
 - 1) curbs.
 - 2) penetration flashings.
- 2) *Curbs* and penetration flashings must extend at least 200 mm (8") above the *Finished Waterproofing System*. Waterproofing of equipment installed on a curb is the responsibility of others.
- 3) Membrane that terminates on any vertical surface must be secured to the vertical substrate by the *Contractor*.
- 4) Sleepers or equipment pads that are completely sealed (enveloped) must be at least 125 mm (5") in height above the finished roof surface. All penetrations through the top surface must be additionally sealed using
 - 1) a compression sealant between the membrane and equipment supports.
 - 2) a universal sealant applied around the edges of equipment supports.
- 5) Except where fully enveloped sleepers are utilized, all membrane flashing (stripping) must extend vertically on perimeter surfaces at least 200 mm (8") above the roof field membrane, to permit a proper watertight seal. Where pavers, ballast, growing media or any other type of *Roof Coverings* are installed on top of the field membrane, both membrane flashing and purpose-made penetration flashings must extend vertically past the top surface of the covering (the *Finished Waterproofing System*) at least 200 mm (8") (see **11.1.2 Drainage**; see also **11.3.2.5 Scuppers and Overflows**).
- 6) Penetration flashings for new construction *Projects* must be located at least 300 mm (12") away from any adjacent drain, penetration, upstand, edge or *wall*. The separation space is measured between openings, excluding the flange.
- 7) Roof penetration flashings designed for a single penetration must
 - 1) be suitable for only a single rigid penetration.
 - 2) be properly fitted to form or permit a seal around the penetration.
 - 3) trimmed to eliminate sharp corners.
 - 4) fully supported from the *deck*.
 - 5) not be used with multiple pipe roof penetrations.
 - 6) sealed to the penetration with a stainless-steel clamping ring and sealant applied to the membrane edge.
- 8) Multiple or flexible penetrations may not be flashed with an open-topped flashing filled with sealant, but must be sealed into the *roof assembly* with one of the following options:
 - 1) Electrical cable penetrations
 - 1) must pass through a gooseneck-type flashing with a weather hood.
 - 2) should be drooped to prevent water ingress through the flashing.
 - 2) Pipe-type penetrations must be sealed with

- 1) the manufacturer's proprietary rubber-based friction seals, mechanical clamps or gooseneck type design.
 - 2) a 2-part site-fabricated or proprietary retrofit flashing with a removable inspection/access cap.
 - 3) roof curbs and customized metal hoods.
- 9) Where a purpose-made flashing does not fit the penetration, the joint between the penetration and the flashing must be sealed using one of the following methods:
- 1) using a site-formed non-bituminous flexible roof membrane storm collar, which is
 - 1) fashioned from semi-cured EPDM or its equivalent.
 - 2) installed free of wrinkles or fish-mouths.
 - 3) fully wrapped around the penetration and flashing and installed so that the membrane overlaps both the penetration and the flashing at least 50 mm (2").
 - 4) loosely wrapped around the penetration at least 1 ½ times or adhered to itself and overlapped at least 50 mm (2").
 - 5) clamped both at the top and at the bottom with stainless steel clamps set back from the membrane edge no more than 6.35 mm (1/4").
 - 2) with a heat-shrink wrapped membrane termination
 - 1) extending 50 mm (2") onto both the penetration and the flashing.
 - 2) secured with a stainless-steel mechanical compression strap.

Regardless of the above method, a compatible sealant must be applied between the penetration and the collar or heat-shrink wrapping.

See **Figure 11.3.3.1-1** below for an illustration of these Standards.

Figure 11.3.3.1-1

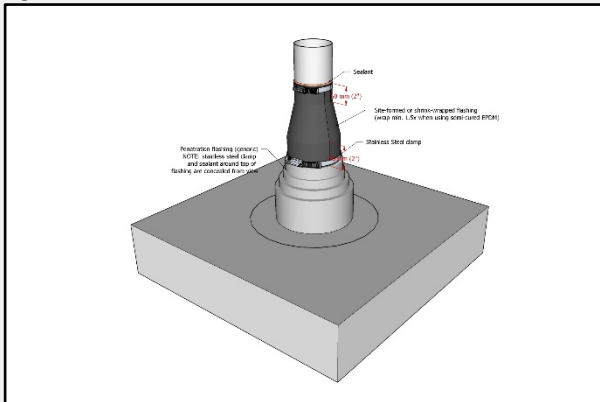

- 10) Galvanized, hot-welded flashings and vents may be installed on
- 1) *Uninsulated Systems or Conventionally Insulated Systems*, provided the vents
 - 1) measure no more than 350 mm x 350 mm (14" x 14") in size, equal to approximately 0.12 meter squared (196 sq. in.) (Larger vents must be installed on curbs).
 - 2) are not located in or near a valley and are well drained.
 - 2) slopes less than 1:50 (1/4" in 12"), provided the vents are coated on all surfaces to a point at least 100 mm (4") above the *Finished Waterproofing System* with a one or two-part liquid flashing acceptable to the membrane manufacturer.
 - 3) *Protected Membrane Roof Systems or Modified Protected Membrane Roof Systems* provided the vents are mounted on membrane-flashed curbs.
- 11) When a pipe-type penetration is flashed with a cylindrical or conical purpose-made metal flashing that does not incorporate a fitted cap, the penetration must be protected immediately above the exposed top of the

flashing with at least one properly fitted, level storm collar. All storm collars must be sealed at the top edge with an acceptable sealant.

This Standard applies to B-vent penetrations also.

- 12) Housekeeping pads situated on top of the finished roof surface and supporting a combined load less than 90 kg (200 lbs) must be separated from the roof with a bond-breaking layer (i.e. XPS insulation, or a drainage mat). Housekeeping pads supporting larger loads must conform to the Standards for sleepers or equipment pads.
- 13) Pourable sealant pockets should be used only when a purpose-made flashing is not available or practicable.

11.3.3.2 [NOT USED]

11.3.3.3 [NOT USED]

11.3.3.4 Sealant Pockets

- 1) When pourable sealant pockets are considered as the last resort to seal a penetration,
 - 1) the penetration surfaces must be properly prepared following the sealant manufacturer's instructions, to ensure a good bond between the penetration and the sealant.
 - 2) unless exceeded by the published instructions of the manufacturer, sealant pockets must be
 - 1) cleaned and primed.
 - 2) at least 50 mm (2") deep.
 - 3) large enough to provide at least 25 mm (1") of fillable space on all sides of the penetration.
 - 4) crowned with sealant to shed water.
 - 3) only the membrane manufacturer's approved proprietary UV-stable urethane-based structural sealants may be used to fill sealant pockets.
 - 4) sealant pockets must be sealed to the roof membrane.
 - 5) a site-formed non-bituminous flexible roof membrane storm collar must be fitted and secure it to the penetration with stainless steel clamps.

11.3.4 Guardrails

- 1) **Guardrails should be installed only on vertical surfaces; attachment of guardrails to a horizontal surface is strongly discouraged.**
- 2) Where guardrails are fastened through the top of copings, the base shall be installed in a continuous bed of compression sealant, but in any event, a written Variance must be requested from the Guarantor. Guardrails shall not direct water into a *roof system* by means of weep holes or the method of fastening, and mounts and flashings shall be installed at least 87.7 mm (3 ½") above the roof surface.

12 PROTECTED MEMBRANES and OTHER DETAILS

12.1 Protected and Modified Protected Membrane Roof Assemblies

This Part pertains to the design and installation of roofs that are designed and constructed as *Protected Membrane Roof Systems* or *Modified Protected Membrane Systems*; in these systems, gravel ballast or pavers are used to secure the *system* materials against wind uplift and floatation in water. For roofs designed with accessible coverings, refer to **Part 14 THE ROOF as a PLATFORM: Coverings, Living Spaces and Structures**.

12.1.1 Design

- 1) Only fully adhered membranes are permitted for application on a *Protected Membrane Roof System*. Adhered EPDM membranes may be used in a *Protected Membrane Roof System*, but because EPDM is fundamentally different in electrical conductivity from other RoofStar-accepted membranes, the *Design Authority* is urged to consult one of the recognized electronic leak detection service providers about available technologies and associated costs to provide an integrity scan. See also **1.6 RoofStar Guarantee: Coverage and Limitations** for integrity scan requirements.
- 2) When a roof is designed as a *Protected Membrane Roof System* or as a *Modified Protected Membrane System*, it must be secured in keeping with the design standards and ballast weight requirements in **Part 3 SECURING the ROOF ASSEMBLY**. In addition, the roof must be designed to incorporate
 - 1) gravel ballast guards around drains.
 - 2) a drainage layer beneath XPS insulation.
 - 3) filter fabric installed over XPS insulation, in order to
 - 1) contain the insulation and thereby prevent 'insulation stacking' (displacement) when insulation boards become buoyant in water.
 - 2) prevent fines from settling at the membrane level and filling the voids between insulation board joints.
- 3) Where membranes installed on vertical surfaces may be damaged from foot traffic or shifting coverings, they must be protected as, for example, with base metal flashings.
- 4) Every *Protected Membrane Roof System* or *Modified Protected Membrane System* designed with gravel ballast must conform to the securement requirements set out in **3.3.3.2 Ballasted Roof Systems** and specify ballast conforming to the minimum requirements shown in the table below.

Table 12.1 RGC Ballast Guide

XPS Insulation Thickness	Stone Ballast Required Weight	Ballast Depth (approximate)
Up to 50 mm (2")	60 Kg/M ² (12 lb./sf)	40 mm (1 ¾")
75 mm (3")	8r Kg/M ² (17 lb./sf)	60 mm (2 ¼")
100 mm (4")	108 Kg/M ² (22 lb./sf)	75 mm (3")
125 mm (5")	132 Kg/M ² (27 lb./sf)	90 mm (3 ½")
150 mm (6")	156 Kg/M ² (32 lb./sf)	105 mm (4 ¼")
175 mm (7")	180 Kg/M ² (37 lb./sf)	125 mm (5")
200 mm (8")	204 Kg/M ² (42 lb./sf)	140 mm (5 ½")

12.1.2 Materials

See also **3.2.2 Gravel Ballast** in **Part 3 SECURING the ROOF ASSEMBLY**.

- 1) Membranes must conform to the material requirements set out in **9.2.1 Composition, Thickness and Selection**.
- 2) Insulation must be Type IV XPS and must be supplied by the *Contractor*. Refer to **7.2 Materials**.
- 3) Drainage mats and filter fabrics must conform to the Standards set out for *Overburdens* in **14.2.4 Components for Vegetated Systems and Other Roof Coverings**.

- 4) Pavers that are partially supported (i.e. with pedestals) should be capable of resisting anticipated loads (consider, for example, hydraulically pressed concrete pavers).
- 5) Pedestals
 - 1) **should be adjustable, when a level surface is required.**
 - 2) must be proprietary (purpose-made) and include an integral spacer rib measuring at least a 3mm (1/8"), to uniformly separate pavers.
- 6) Gravel ballast used to secure a *Protected Membrane Roof System* or *Modified Protected Membrane System* must be clean, washed, round or crushed stone, falling within the following gradations:
 - 1) 35 mm (1 1/2") - 100 % Passing
 - 2) 25 mm (1") 70 - 100 % Passing
 - 3) 20 mm (3/4") 5 - 20 % Passing
 - 4) 12.7 mm (1/2") 0 - 6 % Passing
 - 5) 5 mm (3/16") 0 - 2 % Passing

Any variance to the above must be accepted by the owner or the owner's representative and be confirmed in writing.

12.1.3 Application

12.1.3.1 General

- 1) All components of a *Protected Membrane Roof System* or *Modified Protected Membrane System*, including the gravel or paver ballast, must be supplied and installed by the *Contractor*. Where a *Vegetated System (VRS)* is used as ballast, the *VRS* may be installed by others but
 - a. the work must be coordinated with the *Contractor*.
 - b. the *VRS* must be installed immediately upon completion of the *Contractor's* work, to ensure the *roof system* is held in place.

See also **12.1.3.5 Filter Fabric** and **14.1.2.2 Roof Coverings**.

12.1.3.2 Membranes

- 1) Membranes, membrane flashing and insulation must be installed in keeping with the Standards found elsewhere in this *Manual*.
- 2) No UV-sensitive membrane may be left exposed to UV radiation and must be fully protected by a granulated cap membrane, metal flashing or *Overburden*.
- 3) The primary membrane and membrane flashing must meet the requirements in **9.2.1 Composition, Thickness and Selection** for thickness and reinforcement.
- 4) All membrane flashing must be carried up the vertical surface at least 200mm (8") higher than the top of the ballast.
- 5) Before any *roof covering*, structure or equipment is installed, roof membranes must be
 - 1) inspected.
 - 2) scanned for leaks when an integrity scan is specified.
 - 3) free of deficiencies.

12.1.3.3 Insulation

- 1) Insulation must be installed by the *Contractor*.

12.1.3.4 Drainage and Penetrations

- 1) A drainage mat must be installed below the XPS insulation. A second drainage layer may be installed above the insulation but is at the discretion of the *Design Authority*.
- 2) Specialized proprietary drainage products must be acceptable to the membrane manufacturer.
- 3) Ballast guards must be installed around all roof drains. See **11.2.2 Roof Drains & Scuppers**.
- 4) For drains and penetrations, refer to the Standards in **Part 11 DRAINS and PENETRATIONS**.

12.1.3.5 Filter Fabric

- 1) Fabric filter mats must be
 - 1) installed loose-laid (un-bonded) over the insulation and below any type of ballast or roof covering.
 - 2) overlapped at all edges a minimum of 300mm (12").
 - 3) at least 2.5 m x 2.5 m (8' x 8') in size.
 - 4) slit to fit over roof penetrations and cut out around roof drains and other openings.
- 2) Filter fabric must extend up perimeter edges and *curbs* and must be placed loose (unattached) under metal counter flashings or wall finishes. See also **13.3.5 (6)** concerning *Linear Metal Flashings*.

12.1.3.6 Gravel and Paver Ballast

- 1) Gravel or pavers used as ballast on a *Protected Membrane Roof System* constitute part of the *roof system* and therefore each kind of ballast must
 - 1) conform to the minimum requirements set out in **Part 3 SECURING the ROOF ASSEMBLY**.
 - 2) be evenly distributed or installed over the insulation, drainage layer and filter fabric assembly.
 - 3) be supplied and installed by the *Contractor*, not by another trade.
- 2) Pavers and unit-type masonry, such as brick or stone, must be supported by
 - 1) proprietary (purpose-made) pedestals with at least a 3mm ($\frac{1}{8}$ ") integral spacer ribs for uniform spacing of pavers.
 - 2) a proprietary drainage layer overlaid with a filter fabric mat.
 - 3) a drainage layer of loose aggregate (such as pea gravel) measuring at least 25 mm (1") in depth, installed over a filter fabric.
- 4) Pedestals or a drainage layer must permit at least 12.7 mm ($\frac{1}{2}$ ") of vertical separation between the paver and the underlying substrate, to provide airflow for drying surfaces and assist in leveling. **Pedestals should not impede the flow of water or air, and should uniformly distribute the dead load of pavers, and other unit masonry products, as well as predicted live loads.**

12.2 Built-in Membrane Gutters

12.2.1 Design

- 1) When a built-in membrane gutter adjoins a RoofStar-guaranteed *Water-shedding System*, the gutter waterproofing must be constructed by the *Contractor* to be included by the **RoofStar Guarantee**. Built-in membrane gutters that drain a roof not covered by a **RoofStar Guarantee** are not eligible for a **RoofStar Guarantee**.
- 2) *Conventionally Insulated Systems* that drain into a built-in gutter must abut solid blocking at the gutter edge that provides
 - 1) a stop for the insulation assembly.
 - 2) a solid substrate for the securement of flashings and membranes.
- 3) The *Design Authority* is responsible to design the gutter for its anticipated capacity, with consideration given to
 - 1) rainfall and snow load calculations for the building location.
 - 2) drain type, size and flow rate.
 - 3) size and placement of the overflow drain

For rainfall and snow load capacities, refer to the *British Columbia Building Code, Div. B, Appendix C, Table C-2* which lists various types of loads, including rain and snow loads, for specific reference locations throughout the province.

- 4) Only fully adhered membranes or acceptable metal gutter liners may be used in built-in gutters.
- 5) When a *Waterproofing System* transitions to a *Water-shedding System* by way of a common built-in gutter, the gutter membrane must be carried up the *Water-shedding System* slope (when measured vertically from the maximum water level)

- 1) at least 150 mm (6"), or
 - 2) at least 300 mm (12") in regions with typical heavy snow.
- 6) New gutters shall be designed with a minimum width of 300 mm (12") and a depth not exceeding the gutter's width. At least 100 mm (4") clearance on the horizontal plane is required between any gutter wall and the
- 1) the edge of the drain bowl for spun drains.
 - 2) the edge of the drain leader for flat spun or welded drains.

Cast drains must be installed according to the requirements set out in **11.3.2 Roof Drains**.

- 7) To qualify for a **RoofStar Guarantee**, existing gutters should be redesigned if their capacity is undersized, but they must nevertheless incorporate an overflow drain in keeping with the Standards in this Part. Where the primary drain in an existing gutter is undersized for the capacity of the gutter, the primary drain must be replaced with a properly sized drain.
- 8) An overflow drain must be located at least
 - 1) 100 mm (4") above the primary gutter drain.
 - 2) 25 mm (1") below any mechanical fasteners used to secure the adjoining roof assembly.
- 9) For transitions between the built-in gutter and steep roof assemblies, refer to Part 10 in any of the [Water-shedding Systems](#) Standards.

12.2.2 Materials

NOTE: These material standards are applicable to membrane gutters for all membrane-based waterproofing systems; hence, references to various membrane types.

- 1) Only EPDM, PVC, TPO, 2-ply modified bituminous membranes or reinforced PMMA are acceptable for this application:
 - 1) Single-ply non-bituminous membrane thickness must be no less than 60 mils (1.524 mm).
 - 2) 2-ply bituminous membranes must meet the minimum thickness requirements in **9.2.1 Composition, Thickness and Selection**.
 - 3) Reinforced PMMA liquid membrane systems approved for field use, applied on an accepted SBS-modified base membrane.
- 2) A metal gutter liner may be fabricated from
 - 1) copper sheet material, incorporating soldered seams.
 - 2) stainless steel, incorporating welded seams.

See **13.2.1 Sheet Metal Grade and Gauge** for gauge requirements. See also *Application* below.

12.2.3 Application

- 1) All gutter membranes must be installed according to the membrane manufacturer's published instructions.
- 2) Gutter membranes must be
 - 1) installed perpendicular to the gutter length.
 - 2) carried up an adjoining *Water-shedding System* (measured vertically from the maximum water level)
 - 1) at least 150 mm (6"), or
 - 2) at least 300 mm (12") in regions with typical heavy snow.
 - 3) lapped under and sealed to the adjoining membranes at least 150 mm (6").
 - 4) installed in keeping with Application requirements in this *Manual*.
- 3) Gutter membranes must be mechanically secured at their terminations, both on the outside of the gutter edge and on the field:
 - 1) Fasteners securing the membrane on the field must be placed at least 150 mm (6") above the maximum water level.
 - 2) Securement fastener spacing shall be no more than 300 mm (12") O.C.
- 4) Gutter drains and overflows must be installed in keeping with the requirements outlined in **12.2.1 Design**. Drain flanges that are bent to accommodate the side walls of the gutter must be mechanically fastened to

the gutter wall before membrane application. Refer to the **RoofStar Guarantee Standards** for roof drains in any of the Standards for *Waterproofing Systems*.

- 5) A metal gutter liner
 - 1) fabricated from copper sheet material must incorporate soldered seams.
 - 2) fabricated from stainless steel must incorporate welded seams.
 - 3) must be installed
 - 1) over an adhered single-ply membrane no less than 2.3 mm (bituminous membranes) or 60 mils (non-bituminous membranes).
 - 2) with a slip sheet between the membrane and the metal liner to prevent damage to the membrane caused by the liner at its joints.
 - 6) When an adjoining *Water-shedding System* is insulated (typically ASM only), the transition from gutter to the *Water-shedding System* may require the use of tapered insulation incorporating a drainage plane between layers of tapered insulation. See Construction Detail [ASM 12.1.2 Built-in Gutter Assembly](#) for an illustrated example.
-

13 METAL FLASHINGS

13.1 General

This Part pertains to *Linear Metal Flashings* (different from penetration flashings), fabricated from sheet metal and designed to divert water away from the membrane flashing termination, usually onto the roof. *Linear Metal Flashings* also protect the membrane from weathering and damage, provides an aesthetic finish to the roof assembly. *Linear Metal Flashings* are not a waterproofing component. Consequently, the roofing membrane should be continuous beneath the metal (see membrane flashing requirements under **Part 10 PERIMETERS and WALLS** and **Part 11 DRAINS and PENETRATIONS**).

Linear Metal Flashings include, without limitation,

- Coping (cap) flashing.
- Counterflashing.
- Base flashing.
- Fascia flashing.
- Perimeter edge flashing (similar to a “gravel stop” flashing).

For further details, the *Sheet Metal and Air Conditioning Contractors National Association, Inc.* (SMACNA) publishes a reliable reference for the proper design and installation of architectural sheet metal.

13.1.1 Definitions

Refer to the [Glossary](#) for further definitions of key terms used in this *Manual*.

13.1.2 Design

13.1.2.1 RoofStar 15-Year Guarantee

- 1) Only metal flashings fabricated from 24-gauge stock (or thicker) qualify for a **RoofStar 15-Year Guarantee**.

13.1.2.2 All Projects

- 1) *Linear Metal Flashings* described in any Part of this Standard are considered necessary and integral to the scope of a *Project* designed and constructed to qualify for a **RoofStar Guarantee**. Furthermore, only new *Linear Metal Flashings* may be specified and installed; reuse of any existing *Linear Metal Flashings* is prohibited and may void the **Guarantee**. See also **1.6 RoofStar Guarantee: Coverage and Limitations**.
- 2) Subject to the requirements in this Standard, the *Design Authority* must specify
 - 1) metal type, finish and gauge.
 - 2) seam types.
 - 3) length of flashings (if different from the **Guarantee Standards** outlined below).
 - 4) method of attachment (concealed or exposed fasteners).
- 3) Design drawings must detail metal flashing profiles desired for the *Project*; keep metal flashings away from the water plane or standing water by at least 25 mm (1”).
- 4) Membranes that are UV-sensitive must be protected with *Linear Metal Flashings* but they are not required when the membrane is continuously sealed and otherwise protected from UV radiation (as, for example, sleepers enveloped with a UV-resistant or granule-surfaced membrane).
- 5) All exposed membrane edges must be protected with *Linear Metal Flashings* or a 2-part reinforced liquid flashing (in conformity with **11.3.3.3 Liquid Membrane Flashing**).
- 6) **Notwithstanding the foregoing, the *Design Authority* may specify metal flashings to cover parapet caps, sleepers or curbs**
 - 1) **for aesthetic reasons.**
 - 2) **to protect the membrane from damage resulting from maintenance, pressure washing of decks or pavers, or foot traffic.**

- 7) When the top surface of a wall exceeds 100 mm (4") in width, it must be sloped to promote drainage; slope the top surface at least 2% toward the roof. **Drainage toward the exterior of a building is not recommended.**
- 8) All metal cap (coping) flashings must be fully supported.
- 9) As length and breadth of metal cap (coping) flashings increases, it is necessary to adjust the gauge and length of flashing segments to counteract anticipated distortions. Each type of metal will behave differently. The following standards apply to the use of pre-finished galvanized steel (the most commonly used material for metal flashings) when stiffeners or cross-breaking are not used to counter-act oil canning. The *Design Authority* must specify slope, gauge and length using the standards in the table below:

Table 13.1 Pre-finished Galvanized Steel Cap (Coping) Flashing (Gauge and Length Standards)

Horizontal span	Minimum Slope	Gauge	Maximum Flashing Segment Length	Seam Options
Up to 300 mm (12")	2%	26, 24	3000 mm (10')	S-lock or Standing Seam
		22+		Butt seams*
300 – 900 mm (12" to 36")	4%	24	3000 mm (10')	S-lock or Standing Seam
		22+		Butt seams*
900 mm or greater	6%	24	1200 mm (4')	S-lock or Standing Seam
		22+		Butt seams*

*Refer to 13.3.3 Seams

- 10) To minimize oil-canning of metal flashings attached vertically, without the use of stiffener ribs or cross-breaking, the following standards apply to pre-finished galvanized steel, which is the most commonly used material for metal flashings. **The *Design Authority* should specify slope, gauge and length using the standards in the table below:**

Table 13.2 Pre-finished Galvanized Steel Vertical Flashing (Gauge and Length Standards)

Vertical face	Gauge	Maximum Flashing Segment Length	Vertical Seam Options
Up to 150 mm (6")	26	3000 mm (10')	S-lock
Up to 200 mm (8")	24	3000 mm (10')	S-lock
Up to 300 mm (12")	22+	3000 mm (10')	Butt seams*

*Refer to 13.3.3 Seams

- 11) ***Drip edges are not required, but strongly recommended for Linear Metal Flashings around the outside perimeter of a building, in order to protect wall finishes, and*** when *drip edges* are used they must extend at least 12 mm (1/2") from the vertical face.
- 12) All flashings, regardless of their profile or application, must be hemmed.
- 13) Where a parapet intersects with a wall, water must be directed to the outer surface of the wall by flashing the union with
 - 1) membrane flashing.
 - 2) membrane gussets at the corners.
 - 3) a metal saddle assembly.
- 14) When flat butt seams are specified (as permitted by these Standards), their design and material requirements must conform to the Application standards in **13.3.4 (9)**.
- 15) All membrane flashing terminating on any vertical surface must be secured to the vertical substrate by the contractor. Exposed membrane edges must also be protected from UV radiation, and from water intrusion. This must be accomplished using one of the following options, ranked according to the maintenance they require (low to high):
 - 1) Adhere the roof membrane to the wall surface, and

- 1) protect the exposed membrane edge with overlapping wall membranes and exterior sheathing (**Figure 10.1a**).
- 2) cover the exposed membrane edge with a secondary, fleece-reinforced 2-component liquid membrane flashing (see **10.3.8** for application requirements) (**Figure 10.1b**).
- 2) Mechanically secure the membrane to the wall with a termination bar; caulk the upper edge of the termination bar, and cover the bar with a cut reglet flashing sealed inside the reglet cut with an acceptable sealant (see **13.2.4 Sealants**) (**Figure 10.1c**).
- 3) When the use of a cut reglet is impractical, a surface reglet flashing may be used on smooth surfaced substrates:
 - 1) Mechanically secure the membrane to the wall with a termination bar or metal flashing; caulk the upper edge of the termination bar, and cover the bar with a secondary metal surface reglet flashing that is separately attached to the wall and sealed along the upper edge with an acceptable sealant (see **13.2.4 Sealants**) (**Figure 10.1d**).
 - 2) Mechanically secure the membrane to the wall; surface-mount a reglet flashing above the terminated membrane and seal the metal flashing along the upper edge with an acceptable sealant; install a second surface-mounted reglet flashing and seal it along the upper edge with an acceptable sealant (see **13.2.4 Sealants**) (**Figure 10.1e**).

For fastener spacing, see additional Standards in **13.3.1 General** (Application). For specific construction requirements, refer to the **Construction Details** Division in this *Manual*.

13.2 Materials

13.2.1 Sheet Metal Grade and Gauge

- 1) A mill certificate must be provided by the *Contractor* when requested by the *Design Authority*.
- 2) The following minimum gauges and / or weights of commonly used metals or alloys are acceptable for use in the **RoofStar Guarantee Program**.

GALVANIZED STEEL: minimum 0.50 mm (0.0196", 26-gauge) galvanized steel sheet, conforming to *ASTM A653 / A653M-06* CS Type B, Z275 (G90) coating. Thickness tolerance as per *ASTM A924 / A924M-06* ± 0.08 mm (0.003") for sheet widths not exceeding 1500 mm (60").

ALUMINUM – ZINC ALLOY COATED STEEL: minimum 0.50 mm (0.0196", 26-gauge) aluminum-zinc alloy coated steel sheet, conforming to *ASTM A792 / A792M-06* CS Type B, AZM150 (AZ50) coating. Thickness tolerance as per *ASTM A924 / A924M-06* ± 0.08 mm (0.003") for sheet widths not exceeding 1500 mm (60").

ALUMINUM: minimum 0.80 mm (0.032", 20-gauge) aluminum sheet, utility quality to CSA HA Series - 1975, plain or embossed finish. Maximum thickness tolerance variation ± 0.06 mm (0.0025") based on 1200 mm (48") wide sheet.

STAINLESS STEEL: minimum 0.38 mm (0.014", 28-gauge) stainless steel, Type 302, 304, 316, 2B finish to *ASTM A167-82*. Maximum thickness tolerance variation ± 0.04 mm (0.0015") based on 1200 mm (48") wide sheet.

COPPER: minimum 0.56 mm (0.022", 16 oz.) copper sheet, cold rolled roofing copper to *ASTM B370-81*. Maximum thickness tolerance variation ± 0.09 mm (0.0035") based on 1200 mm (48") wide sheet.

ZINC: minimum 0.80 mm (0.031") zinc Sheet conforming to European standard *EN 988-1996*. Maximum thickness tolerance variation ± 0.03 mm (0.0012").

Specifying authorities should indicate the type and gauge of metal required, as well as the qualifying standards. The reference standard for gauges is USS REV (metric in mm).

13.2.2 Pre-painted Finishes

- 1) When a painted finish on *Linear Metal Flashings* is specified, only SMP and PVDF pre-painted finishes are acceptable. Where Architectural Metal Roofing is installed, adjoining *Linear Metal Flashings* must have the same finish as the metal panels (PVDF).

13.2.3 Fasteners

- 1) All fasteners used to secure metal flashings must be No. 8 corrosion-resistant screw or expansion fastener with a low-profile head and must be compatible with both the metal flashing material and the substrate.
- 2) Cladding fasteners (screws) with gasketed washers, used as exposed fasteners for *Linear Metal Flashings*, must be No. 8 or larger, and must be made of metal compatible with, and corresponding in colour to, the flashing material.
- 3) Blind rivets are acceptable for securing two *Linear Metal Flashings* together.
- 4) Nails are not acceptable as fasteners.

13.2.4 Sealants

- 1) Sealants shall be
 - 1) non-hardening high-quality butyl or polyurethane.
 - 2) available in either gun grade or sealant tape form.
 - 3) suitable for exterior use and able to resist the effects of weathering.
 - 4) compatible with, and able to adhere to, the materials to which they are applied.
- 2) Sealants shall conform to any one of the following:
 - 1) CGSB 19-GP-5M, "Sealing Compound, One Component, Acrylic Base, Solvent Curing".
 - 2) CAN / CGSB-19.13, "Sealing Compound, One Component, Elastomeric, Chemical Curing".
 - 3) CGSB 19-GP-14M, "Sealing Compound, One Component, Butyl-Polyisobutylene Polymer Base, Solvent Curing".
 - 4) CAN / CGSB-19.24, "Multi-Component, Chemical Curing Sealing Compound".

13.3 Application

13.3.1 General

13.3.1.1 RoofStar 15-Year Guarantee

- 1) Only *Linear Metal Flashings* fabricated from 24-gauge stock (or thicker) qualify for a **RoofStar 15-Year Guarantee**.

13.3.2 Fabrication

- 1) **Drip edges are not required, but strongly recommended for flashings around the outside perimeter of a building, in order to protect wall finishes, and when drip edges are used they must extend at least 12 mm (1/2") from the vertical face.**
- 2) All flashings, regardless of their profile or application, must be hemmed.
- 3) The vertical face of cap or counter-flashings must drop vertically at least 62 mm (2 1/2"), not including the drip or hemmed edge.
- 4) Metal edge flashings must be fabricated with a
 - 1) flange measuring no less than 100 mm (4") in width.
 - 2) vertical drop and hemmed drip edge at least 50 mm (2").
 - 3) sloped drop (for transitions to lower *Water-shedding Systems*) of no less than 100 mm (4").
- 5) Metal edge flashings may be constructed with or without an upstand at the outside edge. *Linear Metal Flashings* designed for a draining roof edge may perform best without an upstand (for example, when transitioning to a lower water-shedding roof).

13.3.3 Securement

- 1) Unless otherwise provided for in these Standards, mechanical fasteners used to secure *Linear Metal Flashings* shall be spaced no more than 300 mm (12") O.C.
- 2) Screw fasteners must penetrate the substrate a minimum of 19 mm (3/4").
- 3) Regardless of the type of *Linear Metal Flashing*, all flashing fasteners must be installed at least 87.7 mm (3 1/2") above the *Finished Waterproofing System*.
- 4) Cant edge metal flashings may be mechanically fastened from the outside face.
- 5) Hidden metal clips must
 - 1) be at least 24-gauge.
 - 2) be fastened as close to the bottom edge (hook) as practical but must not be fastened further than a maximum of 75 mm (3") from the bottom edge (hook).
 - 3) engage drip or safety edges by a minimum of 12 mm (1/2").
- 6) Hidden metal clip types include
 - 1) **Continuous Concealed Clips**, which must be attached with fasteners spaced no more than 300 mm (12") O.C.
 - 2) **Discontinuous Concealed Clips**, which must
 - 1) consist of a single clip centred between the seams of each length of metal flashing.
 - 2) measure at least 1/3 of the length of flashing it will secure but shall not be less than 100 mm (4") in length.
 - 3) be fastened with screws spaced no more than 300 mm (12") O.C.
- 7) Fastening the top (horizontal or sloped) surface of a flashing with exposed fasteners is not permitted.
- 8) *Linear Metal Flashings* secured in a reglet must be
 - 1) installed above the membrane flashing.
 - 2) inserted at least 12.7 mm (1/2").
 - 3) friction-fitted within the reglet (groove) or secured on the exposed face with an acceptable fastener.
 - 4) sealed with a continuous bead of tooled gunnable sealant.
- 9) Sealants must be tooled to positively shed water.

13.3.4 Seams

- 1) All joints between lengths of flashing must be fully seamed.
- 2) Regardless of the seam type, allowances should be made for metal expansion and contraction.
- 3) Sealant applied to S-lock or Standing Seams is not a requirement of these Standards, but when it is specified
 - 1) the sealant must be applied along the full length of the seam.
 - 2) any sealant that extrudes from the seam during the seaming process must be removed and discarded (see **1.5 Workmanship**).
- 4) With the exception of flashings made with 22-gauge metal (or heavier), only S-lock seams or standing seams are acceptable when connecting lengths of flashing. See the standards and tables below.
- 5) Notwithstanding other standards in this *Manual*, when *Linear Metal Flashings* join at a corner (regardless of the angle), the top face(s) of the flashings must be joined with a standing seam.
- 6) Flat overlapped seams are acceptable only where
 - 1) the height of an inside corner is less than 100 mm (4").
 - 2) vertical flashings are lapped to fit under counter flashing or equipment flanges.
- 7) Standing Seams must incorporate clips when the seam is longer than 100 mm (4"), and the clips must be
 - 1) fabricated from flat metal stock 24-gauge or heavier.
 - 2) at least 38 mm (1-1/2") wide.
 - 3) spaced apart from each other no more than 200 mm (8") O.C.
 - 4) secured with at least 2 acceptable low-profile flat head screws.

- 8) **S-locked Seams** must be secured through flashing tab (leaf) with at least one (1) acceptable low-profile flat head screw when the seam is longer than 100 mm (4"), but fasteners must not be spaced more than 200 mm (8") O.C.
- 9) **Flat Butt Seams** are permissible only for cap flashings, and only when the flashing is fabricated from steel or aluminum ranging in thickness from 22 to 18-Gauge (the same applies to the equivalents for copper and zinc sheet material, by gauge or weight):
 - 1) Each flashing must have a hemmed front edge fabricated to hook onto a supporting saddle.
 - 2) Each supporting saddle must be
 - 1) manufactured from the same material as the flashing.
 - 2) formed to match the profile of the cap flashing.
 - 3) fabricated with a hook along the front face.
 - 4) secured to the parapet with screws.
 - 5) installed to underlap the butt joint by at least 100 mm (4") on either side.
 - 6) seated in two parallel beads of un-tooled sealant or butyl tape, which must be applied between the saddle and flashing, on either side of the butt joint, to all three adjoining faces.
 - 7) secured to the cap flashing along both faces of the parapet (see **13.3.3 Securement**).
 - 3) When cap flashings span widths greater than 300 mm (12"), the cap flashing must be riveted to the saddle to ensure adequate securement, and the rivets must be no further apart than 200 mm (8").
 - 4) When the specified cap flashing material is thicker or heavier than 18-gauge steel or aluminum, the seam and securement design must be submitted to the *Guarantor* for review prior to tender. This review requirement also applies to copper and zinc flashings that exceed the permissible weight or gauge range.
- 10) Notwithstanding the foregoing, refer to the standards in **Table 13.1** and **Table 13.2 (13.1.2 Design)** for seams, metal gauge and flashing length requirements applicable to metal cap (coping) flashings.

13.3.5 Cap, Counter and Base Flashings

- 1) Cap flashings must be fully supported by a substrate and require a hidden clip to fasten the outside face. The inside face of cap flashings may be secured with
 - 1) a hidden clip.
 - 2) cladding fasteners (see *Materials* above), which must be evenly spaced between seams along each length of flashing. Use no fewer than
 - 1) three (3) fasteners for every 3000 mm (10') length of metal flashing.
 - 2) two (2) fasteners for every 2400 mm (8') length of metal flashing.
 Fasteners may not be used on the outside face of cap (coping) flashing.
- 2) All exposed faces of adjoining lengths of cap flashings must be connected with Standing Seams or S-locks, unless otherwise provided for in this *Manual*. See also **13.3.3.3 Securement**.
- 3) When the outside face of a cap flashing is concealed by a wall assembly, only the outside face may be lap-seamed, provided the overlap is no less than 100 mm (4") and the overlapping metal is embedded in mastic.
- 4) Counter-flashings must be secured to the vertical face, with fasteners or a reglet.
- 5) When the specified cap flashing material is thicker or heavier than 18-gauge steel or aluminum, the seam and securement design must be submitted to the *Guarantor* for review prior to tender. This review requirement also applies to copper and zinc flashings that exceed the permissible weight or gauge range. See also **Butt Seams, 13.3.5 (9)**.
- 6) Metal base flashings are required for walls and curbs when the *roof system* incorporates gravel ballast and filter fabric or where a *Vegetated Roof System* is installed. Metal base flashings must "kick out" minimum 50 mm (2") over insulation and filter fabric. Filter fabric must be tucked up behind the base flashing.
- 7) **Metal base flashings may be fashioned as one piece, but in the alternative, a 2-piece flashing comprised of a lower counter-flashing is the recommended approach, to facilitate roof maintenance.** Install flashings in keeping with other Standards found in this *Manual*.

- 8) When the roof membrane is mechanically secured with a termination bar or a metal flashing,
 - 1) the termination bar profile should be capable of supporting a continuous bead of sealant.
 - 2) a surface reglet flashing must have a hemmed top edge bent outward from the face of the wall by at least 45° and the bent, hemmed edge must measure at least 15.9 mm (5/8") from the break.
 - 3) fasteners must be spaced no more than 300 mm (12") O.C.
 - 4) sealant must continuously fill the groove or top edge of the termination bar and be tooled to shed water away from the wall.
- 9) When a second surface reglet flashing is installed to protect a termination bar or first surface reglet flashing used to secure the membrane,
 - 1) the flashing must be fabricated with a hemmed top edge bent outward from the face of the wall by at least 45° and the bent, hemmed edge must measure at least 15.9 mm (5/8") from the break.
 - 2) it may fastened no more than 600 mm (24") O.C., provided the metal flashing maintains continuous contact with the substrate.
 - 3) sealant must continuously fill the groove and be tooled to shed water away from the wall.
- 10) Where parallel and overlapping reglet flashings are used, the joints between flashing segments must be offset by at least 300 mm (12"), except at corners.

13.3.6 Metal Edge Terminations

- 1) Metal edge flashings (including Gravel Stop flashings) must be installed according to the standards in **10.3.5.2 Metal Edge Terminations**.

13.3.7 Cant Edges

- 1) New and existing cant edges must be covered with a metal flashing and secured to the outside face of the cant with cladding fasteners, which must be evenly spaced between seams along each length of flashing. Use no fewer than
 - 1) three (3) fasteners for every 3000 mm (10') length of metal flashing.
 - 2) two (2) fasteners for every 2400 mm (8') length of metal flashing.
- 2) Metal fabrication and fasteners must conform to the material standards published in this Part.
- 3) When, for aesthetic reasons, a face-fastened cant edge is not desirable, cants may be replaced with
 - 1) a metal edge roof termination (**10.3.5.2 Metal Edge Terminations**).
 - 2) a parapet, designed and constructed in keeping with the minimum height (see **10.1.2 Design**), membrane flashing and metal flashing standards found in this Part.

14 THE ROOF as a PLATFORM: Coverings, Living Spaces and Structures

14.1 General

- 1) This Part covers the design and installation requirements for roofs that support an *Overburden*, whether it is structurally supported or non-structurally situated on the roof platform. These *Overburdens* include
 - 1) Roof Coverings (including, without limitation)
 - 1) gravel ballast.
 - 2) wearing surfaces and living spaces (rooftop terraces) – pavers, wood or composite decks and walkways, cast-in-place concrete, rubberized surfaces and playscapes and pet relief areas.
 - 3) gardens/vegetated assemblies (modular and built-in-place).
 - 2) Structures and Equipment (including, without limitation)
 - 1) planters.
 - 2) furnishings.
 - 3) hot tubs.
 - 4) gazebos, pergolas, nets and wind screens.
 - 5) housekeeping pads.
 - 6) photovoltaics.
 - 7) elevated walkways and stairs; satellite equipment; light standards; signage; lightning rods; sculptures.
 - 8) structural planters, pools and other water features.
- 2) Any *roof covering*, structure or item of equipment must be installed in a manner that protects the roof membrane and its performance.
- 3) Coverage under the **RoofStar Guarantee** may be affected by *roof coverings* or equipment that impede access to the *roof system*. Refer to **Part 1 General** in this Standard.

14.1.1 Definitions

Refer to the [Glossary](#) for further definitions of key terms used in this *Manual*.

Extensive Vegetated Roof Systems

sometimes referred to as 'eco-roofs', 'low-profile green roofs,' ' rooftop gardens' or simply as 'green roofs'

- 1) are installed and maintained without the use of penetrating hand tools.
- 2) utilize pre-assembled trays, boxes, mats or other contained soil or media.
- 3) have minimal plant species diversity.
- 4) are irrigated only to establish plants.
- 5) have a soil depth no more than 150 mm (6").
- 6) are not normally accessed by building occupants.

Inaccessible Overburden

means an *Overburden* that must be demolished in order to access the roof membrane. A concrete split slab is a type of inaccessible *Overburden*.

Overburden (also referred to as a wearing course or layer)

means a *roof covering*, structure or item of equipment that is situated on top of, and covering all or a portion of, a constructed *Waterproofing System*. *Overburden* includes, without limitation,

Roof Coverings

- 1) loose growing media, gravel (used as a covering, not exclusively as ballast), sand or any other granular material.
- 2) void fill.
- 3) tiles, pavers, supporting pedestals or other similar materials.
- 4) vegetated assemblies in trays, mats, other similar containers.

Page 86 of 95

RoofStar Guarantee Standards

for PVC Membrane Systems

Updated July 2020

© RCABC 2020

- 5) cast-in-place concrete.
- 6) playing surfaces.
- 7) pet relief areas.

Structures

- 1) planters, inclusive of everything they contain
- 2) gazebos, decks, benches.
- 3) water features & hot tubs.

Equipment

- 1) satellite / communications.
- 2) lightning rods.
- 3) photovoltaics.
- 4) signage and lighting.

Roof Platform

means a *roof assembly* which supports an overburden or living (amenity) space consisting of *coverings*, structures or equipment that are not part of the *assembly*.

14.1.2 Design

Membrane *roof systems* may be utilized for more than simple weather protection; they can be occupied by casual or regular users, for gardening, playing, lounging, or other leisure activities. Roofs that serve as *amenity spaces* require that the *Design Authority* pay particular attention to the *system* selection itself and, especially, to the protection of the roof membrane.

A *Conventionally Insulated System* is not appropriate for all types of use or *roof coverings*. For example, the designed live loading for occupied spaces, or the weight of a roof covering, may require the *Design Authority* to specify particular materials, and consequently to design a roof as a *Protected Membrane Roof Systems*. Furthermore, some *roof coverings* require maintenance that may result in damage to *Conventionally Insulated Systems*; *Protected Membrane Roof Systems* shield the sensitive membrane from this inevitability.

A *Protected Membrane Roof System* (often referred to as an ‘inverted roof’) offers the designer many benefits, including

- longer lasting membranes.
- capacity for heavier dead and live loads.
- only one control layer to seal and join with the rest of the building envelope.
- fewer waterproofing challenges around penetrations.
- the capacity for electronic leak detection (whether passive or monitored).

For **RoofStar Guarantee Standards** pertaining to the securement of a ballasted *Protected Membrane Roof Systems*, refer to **Part 3 SECURING the ROOF ASSEMBLY, 3.3.2 Ballasted Roof Assemblies**.

Criteria for evaluating the sensitivity of building interiors is left to the *Design Authority*.

This Subsection is written to provide guidance by way of general Standards and Guiding Principles, to assist the *Design Authority* in making the best possible choices for the *roof assembly*.

14.1.2.1 General

- 1) The building structure must be designed to support any live loads required under the Building Code having jurisdiction, together with the loads from any covering, amenity space, structure or live loads superimposed upon the roof platform.
- 2) The *Design Authority* should give thought to the inevitability of roof repairs or replacement when designing the coverings, living spaces or structures the roof will support. This includes, without limitation,
 - 1) access for maintenance.

- 2) material removal, storage and replacement logistics.
- 3) The *Design Authority* is responsible for the appropriate securement design of coverings, living (amenity) spaces and structures, to resist anticipated *Specified Wind Loads*. Where structural securement is desirable or required, it must be made to fully waterproofed structural supports (curbs, sleepers, posts) and must be secured to the structural support at least 200 mm (8") above the water plane. See **Part 11 PENETRATIONS and DRAINS**. See also **Part 3 SECURING the ROOF ASSEMBLY**.
- 4) A roof designed and constructed as a *Protected Membrane Roof System* is strongly recommended when the roof covering or living (amenity) space
 - 1) exceeds 150 mm (6") in depth (excluding any plants).
 - 2) is an intensive or semi-intensive *Vegetated Roof System*.
 - 3) includes cast-in-place concrete surfaces.
 - 4) is installed over a podium roof area adjacent to residential high-rise structures.
 - 5) includes water features or pools.
 - 6) includes expansive terrace areas or play spaces.
- 5) Roofs designed as platforms for *coverings*, amenity spaces and equipment must take into account the following Standards and Guiding Principles:
 - 1) **Load bearing:**
 - 1) **Non-structural installations** - Insulation and *insulation overlays* used in a *Conventionally Insulated System* or *Modified Protected Membrane Roof System* must have a minimum load carrying capacity of 110 Kpa (20 psi), but in any event must be capable of supporting any superimposed loads on the exposed membrane, without compression or distortion of the *roof system* or any one of its components. Otherwise, the roof platform must be designed as a *Protected Membrane Roof System*. See also **8.1.1 Design (Insulation Overlays)**.
 - 2) **Structural installations** - structural supports (i.e. curbs) should be considered to bear heavier dead loads, to resist *Specified Wind Loads*, or to secure the equipment during seismic events.
 - 2) Membrane thickness and puncture resistance: Membranes must be selected for their ability to resist accidental puncture by human activity on the roof; the minimum puncture resistance must be at least 400 N. Refer to the table in **9.1.2** for minimum membrane thickness and puncture resistance requirements.
 - 3) **Protection:**
 - 1) Membranes must be protected from damage incurred
 - 1) during the construction of a building.
 - 2) from normal use and occupancy of the roof.
 - 3) from maintenance of any installation on top of a *roof system*, after the building has been commissioned.
 - 2) To prevent accidental damage and puncture from falling objects, conventional roofs at elevations lower than those designed for human occupancy should include a protective wearing course or, in the alternative, should be designed as a *Protected Membrane Roof System*.
 - 3) Where membranes installed on vertical surfaces may be damaged from foot traffic or shifting coverings, they must be protected as, for example, with base metal flashings. See **13.3.5 Cap, Counter and Base Flashings**.
 - 4) Filter fabrics are required for roof platforms supporting
 - 1) growing media and vegetation.
 - 2) sand and other fine materials.
 - 3) gravel with a diameter less than 12.7 mm (1/2").
 - 4) wet mortar or concrete.
 - 5) XPS insulation above the membrane, in order to contain the insulation and thereby prevent 'insulation stacking' (displacement) when insulation boards become buoyant

in water, and to prevent “fines” from settling at the membrane level and filling the voids between insulation board joints.

4) **Drainage:**

- 1) Roofs designed as platforms to support *roof coverings*, amenity spaces or equipment must promote unimpeded drainage of storm or irrigation water. Where a roof covering material naturally drains (gravel, for example), no additional drainage design is required. In all other cases, the design must incorporate a drainage plane above the supporting roof platform.
- 2) *Overburden* must be contained with drain guards, rigid barriers and filter fabric. See also **11.2.2 Roof Drains and Scuppers**.
- 3) Equipment supports placed on the *roof system* must not impede the flow of water to drains. To facilitate the adequate movement of water when supports are oriented perpendicular to drainage flow,
 - 1) utilize shorter supports, to a maximum length of 1200 mm (4’).
 - 2) incorporate drainage mats beneath the supports longer than 1200 mm (4’) in any direction.

5) **Clearance and accessibility:** equipment installed on structural supports or on top of the roof system must be spaced or located in order to promote access to drains, ease of maintenance and worker or occupant safety.

6) **Integrity Scan:** An Integrity Scan

- 1) must be performed by an RGC-recognized service provider.
- 2) is required on all *Waterproofing Systems*, to ensure the waterproofing is leak and damage-free, when *Overburdens*, amenities or equipment are or will be installed on the completed *Waterproofing System* by
 - 1) anyone other than the *Contractor*.
 - 2) the *Contractor* but only when the *Overburdens*, amenities or equipment exceed 150 mm (6”) in depth.
- 3) is not required when the *Contractor* installs *Overburden*, amenities or equipment equal to or less than 150 mm (6”) in depth.

7) **Electronic Leak Detection** is mandatory for grade-level *Waterproofing Systems*, but optional for *Waterproofing Systems* on roofs.

See **1.3.4 Waterproofing Integrity Scans and Electronic Leak Detection**. See also **1.6 RoofStar Guarantee: Coverage and Limitations**.

14.1.2.2 Roof Coverings

14.1.2.2.1 Gravel

Note that gravel used as ballast on a *Protected Membrane Roof System* or *Modified Protected Membrane Roof System* is considered a means of securement and is covered in **Part 3 SECURING the ROOF ASSEMBLY** and in **12.1 Protected and Modified Protected Membrane Systems**.

- 1) When gravel is specified as the *roof covering*,
 - 1) the design must include gravel guards around roof drains.
 - 2) only washed gravel may be used.
- 2) When the gravel used as a roof covering is crushed, or is smaller than 12 mm (1/2”),
 - 1) a geotextile protection layer must be installed immediately above the roof membrane.
 - 2) the gravel must be deep enough to retain the geotextile protection layer.

14.1.2.2.2 Wearing Surfaces and Living Spaces

- 1) Any wearing surface may be installed on a *Conventionally Insulated System*, provided
 - 1) the compressive strength of the insulation will support it.
 - 2) the insulation in the roof assembly is overlaid with a suitable insulation overlay (see **8.3.1.2 (4)**).
 - 3) the wearing surface does not bond with or touch the roof field membrane or membrane flashing.

- 4) drainage of storm or irrigation water is not impeded.
- 2) When concrete paver walkways or platforms are specified, they must promote free drainage of water. This can be achieved by using adequately spaced
 - 1) pedestals.
 - 2) proprietary pads.
 - 3) XPS insulation.
 - 4) drainage mats.
- 3) *Wearing surfaces may be sloped or level, depending upon the intent of the design, and therefore Project specifications and drawings should indicate this.*
- 4) When cast-in-place concrete is used as a *roof covering* directly over the roof membrane, the concrete must be separated from the membrane with both of the following:
 - 1) A bond-breaking material, such as a proprietary drainage mat or XPS insulation.
 - 2) A filter fabric or barrier material acceptable to the membrane manufacturer, able to prevent the concrete slurry from reaching the membrane.

14.1.2.2.3 Vegetated Roof Systems

- 1) *Modular Vegetated Roof Systems (VRS)* must be designed to resist the *Specified Wind Loads* calculated using the WIND-MVRA online calculator (see also **Part 3 SECURING the ROOF ASSEMBLY**). Since *Vegetated Roof Systems* often provide ballast for *Protected Membrane Roof Systems* and may be installed by someone other than the *Contractor*, the *Design Authority* must specify the coordination of work to ensure the *roof system* is immediately and properly secured.
- 2) *Conventionally Insulated Systems* may be used to support any type of *Vegetated Roof System*, provided
 - 1) the compressive strength of the insulation will support it.
 - 2) the insulation in the roof assembly is overlaid with a suitable insulation overlay (see **8.3.1.2 (4)**).
 - 3) the membrane manufacturer is agreeable to the application and is confident the membrane can withstand the anticipated hydrostatic pressures when the *Vegetated Roof System* is fully saturated with water.
 - 4) the membrane is fully adhered.
- 3) *Notwithstanding the above, Semi-intensive and Intensive Vegetated Roof Systems should be designed as part of a Protected Membrane Roof System.* See also **14.1.2.1 (4)** above.
- 4) Every roof that supports a *Vegetated Roof System* must have, in addition to a drainage layer and membrane protection, a
 - 1) root barrier.
 - 2) filter fabric layer.
- 5) *Vegetated Roof Systems that are built in place should be designed with an additional layer of protection immediately below the growing media and above the rest of the roof system, to ensure the protection of these materials from tools.*
- 6) *Separation Zones*, which are free of growing media or vegetation and protect vulnerable membrane seams from root damage, must be
 - 1) at least 300 mm (12") wide, or greater as determined through *Specified Wind Load* calculations (see also **Part 3 SECURING the ROOF ASSEMBLY**).
 - 2) bordered by a non-penetrating, surface-installed physical barrier (for example, a retention Tee).
 - 3) installed around the perimeter of the *Vegetated Roof System*, and around any of the following, which may be contained within the area covered by the *Vegetated Roof System*:
 - 1) roof drains.
 - 2) roof penetrations.
 - 3) sleepers and curbs.
 - 4) any mechanical equipment not supported by a curb.
 - 5) expansion or control joints.

- 7) Membrane flashing must be protected from damage, both during the installation of *Vegetated Roof System* and during ongoing maintenance. Refer to **Part 13 METAL FLASHINGS** for guidance.

14.1.2.3 Structures and Equipment

- 1) Refer to the general design standards and guidelines in **14.1.2.1 General**.
- 2) Non-structural installations
 - 1) **are strongly recommended whenever practical, since they**
 - 1) **minimize the number of penetrations, curbs or sleepers necessary for structural securement.**
 - 2) **eliminate possible weak points in the roof system, where a leak may occur.**
 - 3) **avoid dedicated mechanical drainage.**
 - 4) **simplify removal of materials when membrane repairs are required.**
 - 2) must be placed on an appropriate protection layer or supported by pedestals, pavers or other means of distributing weight and point loading.
 - 3) may be placed on a *Conventionally Insulated System* provided the insulation is capable of supporting all anticipated dead loads, live loads and point loads (see **14.1.2.1 (1)**).
- 3) A structural concrete planter or water feature that is
 - 1) **cast-in-place should be constructed on a pre-curb that is continuously waterproofed as part of the primary roof membrane and waterproofed independently of the primary roof membrane.**
 - 2) pre-cast must be secured to
 - 1) a pre-curb that is continuously waterproofed as part of the primary roof membrane.
 - 2) structural supports that are waterproofed in keeping with the Standards in **Part 11 PENETRATIONS and DRAINS**.
- 4) When concrete walls or structures are constructed without a pre-curb, all concrete surfaces must be fully and continuously enveloped with the primary roof membrane. See also **1.6 (9)**.
- 5) **Pre-curbs** must be
 - 1) at least 100 mm (4") in height above the water plane of the highest adjacent roof assembly.
 - 2) completely enveloped with fully adhered acceptable membrane flashing (including all faces of drainage knock-outs).
 - 3) properly waterproofed around dowels in their final position with either of the following:
 - 1) a 2-component catalyzed polymethyl methacrylate (PMMA) reinforced liquid membrane flashing system.
 - 2) two cured coats of an Accepted polyurethane or silicon-based single-component liquid flashing system. See **11.3.3.1 General** for application standards.
- 6) When a structural planter adjoins a *Protected Membrane Roof System*, the planter design must include either of the following options for drainage:
 - 1) a plumbed mechanical drain that
 - 1) incorporates a debris guard and maintenance access.
 - 2) extends above the top surface of the growing media at least 50 mm (2").
 - 2) drainage knock-outs in the pre-curb wall, which should be wide enough to allow for the free flow of water over or past of the membrane flashing plies.
- 7) When a structural planter adjoins a *Conventionally Insulated System*, only a plumbed mechanical drain is permissible.
- 8) **A design review is advisable when a structural water features incorporates penetrations for wiring, lights or other submerged features.**
- 9) Tiles or other architectural finishes may be applied to the waterproofing membrane, subject to a written Variance from the *Guarantor* and approval by the membrane manufacturer.
- 10) Drains, re-circulation inlets and outlets used in water features must include clamping rings and must be sealed to the membrane assembly.
- 11) When a leak detection system is specified, or required, only non-ferrous metal drains may be used.
- 12) Drain connections to internal piping must be made with mechanical compression type seals only.

14.2 Materials

14.2.1 Membranes

- 1) Refer to the table in **9.2.1** for minimum membrane thickness and puncture resistance requirements.

14.2.2 Membrane Protection

- 1) Membranes must be protected by using one of the following materials directly above the roof membrane:
 - 1) drainage mat.
 - 2) asphaltic core board measuring at least 3 mm (1/8") thick.
 - 3) XPS insulation measuring at least 25 mm (1") thick.
 - 4) a geotextile protection layer with a minimum thickness/weight of 200 g/m² (used in *Vegetated Roof System* applications, where decorative gravel is crushed or smaller than 12 mm (1/2") in diameter, or where the roof covering, superimposed structure or equipment does not exceed the load-bearing capacity of the protection material).

14.2.3 Insulation and Insulation Overlays

See also **Part 7 INSULATION**

- 1) Insulation used in a *Protected Membrane Roof System* must be Extruded Polystyrene Foam Insulation (XPS).
- 2) When XPS (with or without a concrete topping) is specified as the drainage layer, it must be grooved (by the manufacturer or post-manufacturing).
- 3) Insulation that supports an acceptable roof covering must have a minimum compressive strength equal to or exceeding the dead loads and anticipated overall live loads and point loads of the overburden.
- 4) When an insulation overlay is required (see **14.1.2.2**), it must be a composite product
 - 1) no less than 12.7 mm (1/2") thick.
 - 2) with a minimum compressive strength of 620 kPa (90 psi).

14.2.4 Components for Vegetated Roof Systems and Other Roof Coverings

- 1) While drainage mats, filter fabrics, root barriers and other *Vegetated Roof System* components are ancillary to the *roof assembly*, they nevertheless must be
 - 1) acceptable to the manufacturer of the primary membrane and XPS insulation (when used).
 - 2) suitable for the installed *roof covering*.
 - 3) selected for their ability to support dead loads, live loads and point loads.
 - 4) capable of permitting the anticipated flow rate of water.
- 2) Geosynthetic drainage cores, and geocomposites with factory-laminated filter fabrics, must
 - 1) be molded (dimpled) or woven plastic grids so that it contacts no more than 40% of XPS insulation surface area.
 - 2) be manufactured with a minimum thickness of 9.5 mm (3/8").
 - 3) provide a uniform support for *roof coverings*, structures or equipment installed on the roof platform.
 - 4) have a compressive strength equal to or greater than the design and anticipated live loads of the roof platform and its supported *coverings*, structures or equipment.
- 3) Fabric filter mats must be
 - 1) water permeable and have proven long term weather resistance.
 - 2) strong enough to withstand traffic abuse and prevent displacement of insulation boards under flotation conditions.
- 4) Root intrusion barriers
 - 1) must be sheets or boards that are acceptable to the primary roof membrane manufacturer.
 - 2) may be polyethylene or polypropylene sheeting, provided the material is no less than .2mm (8 mils) thick.
- 5) Membrane protection must be either of the following materials:
 - 1) asphaltic core board measuring at least 3 mm (1/8") thick.
 - 2) XPS insulation measuring at least 25 mm (1") thick.

Page **92** of **95**

RoofStar Guarantee Standards

for PVC Membrane Systems

Updated July 2020

© RCABC 2020

No reproduction of these Standards, in whole or in part, is lawful without the expressed permission of the RGC Guarantee Program.

- 3) a geotextile protection layer with a minimum thickness/weight of 200 g/m² (applicable when the gravel is crushed or smaller than 12 mm (1/2") in diameter).
- 6) Moisture retention and reservoir layers must be acceptable to the manufacturer/supplier of the *Vegetated Roof System*.

14.2.5 Decorative Gravel

- 1) Decorative gravel (different in function from gravel ballast) must be washed and may be smooth or crushed.
- 2) Large grade gravel may withstand wind scour more effectively than smaller gravel. The *Design Authority* should determine the gradients, based on the *Specified Wind Loads* for the roof. For size options, see **12.1.2 (6)** for *Protected Membrane Roof Assemblies*.

14.2.6 Pavers and Pedestals

- 1) Pavers that are partially supported (i.e. with pedestals) should be capable of resisting anticipated loads (consider, for example, hydraulically pressed concrete pavers).
- 2) Pedestals
 - 1) **should be adjustable, when a level surface is required.**
 - 2) must be proprietary (purpose-made) and include an integral spacer rib measuring at least a 3mm (1/8"), to uniformly separate pavers.

14.3 Application

14.3.1 General

14.3.1.1 Membranes

- 1) Membranes and membrane flashing must be installed in keeping with the Standards found elsewhere in this *Manual*.
- 2) Protection of roof membranes from mechanical damage caused by tools, accident or the work of others is mandatory during the installation and maintenance of any *roof covering* or living space.

14.3.1.2 Drainage

- 1) A drainage mat must be installed below the XPS insulation. A second drainage layer may be installed above the insulation. but this is at the discretion of the *Design Authority*.
- 2) Specialized proprietary drainage products must be acceptable to the membrane manufacturer.

14.3.1.3 Filter Fabric

- 1) Fabric filter mats must be
 - 1) installed loose-laid (un-bonded) over the insulation and below any type of ballast or *roof covering*.
 - 2) overlapped at all edges a minimum of 300mm (12").
 - 3) at least 2.5 m x 2.5 m (8' x 8') in size.
 - 4) slit to fit over roof penetrations and cut out around roof drains and other openings.
- 2) Filter fabric must extend up perimeter edges and *curbs* and must be placed loose (unattached) under metal counter flashings or wall finishes. See also **13.3.5 Cap, Counter and Base Flashings** concerning *Linear Metal Flashings*.

14.3.2 Roof Coverings

14.3.2.1 Decorative Gravel

- 1) When gravel is specified as a *roof covering*, only washed gravel may be used.
- 2) Ballast guards must be installed around all roof drains. See **11.2.2 Roof Drains & Scuppers**.
- 3) Crushed gravel specified as a *roof covering* must be installed over a geotextile protection layer, or its equivalent, when the gravel is crushed or smaller than 12 mm (1/2") in diameter.

14.3.2.2 Wearing Surfaces and Living Spaces

- 1) Pavers and unit-type masonry, such as brick or stone, must be supported by

- 1) proprietary (purpose-made) pedestals with at least a 3mm (1/8") integral spacer ribs for uniform spacing of pavers.
 - 2) a proprietary drainage layer overlaid with a filter fabric mat.
 - 3) a drainage layer of loose aggregate (such as pea gravel) measuring at least 25 mm (1") in depth, installed over a filter fabric.
- 2) Pedestals or a drainage layer must permit at least 12.7 mm (1/2") of vertical separation between the paver and the underlying substrate, to provide airflow for drying surfaces and assist in leveling. Pedestals should not impede the flow of water or air, and should uniformly distribute the dead load of pavers, and other unit masonry products, as well as predicted live loads.

14.3.2.3 Vegetated Roof Systems

- 1) All *Vegetated Roof Systems* must be installed as specified and shown on drawings, and in any case must include a
 - 1) root barrier.
 - 2) drainage layer.
 - 3) filter cloth.
- 2) Roofs that support built-in-place soil or growing media beds should include an additional penetration-resistant protection course between the growing bed and other vegetated assembly materials. The protection course prevents damage to these materials whenever sharp-pointed or edged tools are used for the maintenance of the *Vegetated Roof System*.
- 3) Root intrusion barriers must be
 - 1) installed in a continuous plane above the roof membrane.
 - 2) located within the *Vegetated Roof System* as specified by the *Design Authority*.
 - 3) sealed at all seams and laps with a compatible tape, as directed by the manufacturer's instructions.
 - 4) carried up the inside of soil retention perimeters (separation zones).
 - 5) sealed to the *Separation Zone* edge material.
- 4) *Separation Zones* must be
 - 1) at least 300 mm (12") wide.
 - 2) bordered by a non-penetrating, surface-installed physical barrier.
 - 3) installed along all roof perimeters.
 - 4) installed around
 - 1) up-stands.
 - 2) roof drains.
 - 3) penetrations.
 - 4) sleepers and curbs.
 - 5) mechanical equipment.
 - 6) expansion or control joints.

14.3.3 Structures and Equipment

- 1) Structural planters and water features (pools, ponds, water courses) must be constructed with
 - 1) a pre-curb (start-up curb), onto which the planter or water feature wall is formed and poured.
 - 2) full-height walls that are formed and poured in direct contact with the structural *deck*.
- 2) **Pre-curbs** must be
 - 1) at least 100 mm (4") in height above the water plane of the highest adjacent roof assembly (see Construction Detail [SBS 14.3.3 Structures and Equipment \(planter pre-curb\)](#) as an example).
 - 2) completely enveloped with fully adhered acceptable membrane flashing (including all faces of drainage knock-outs).
- 3) Full-height walls must be fully enveloped with roof membrane, on all faces. See **Figure 14.3.1**.

Figure 14.3.1

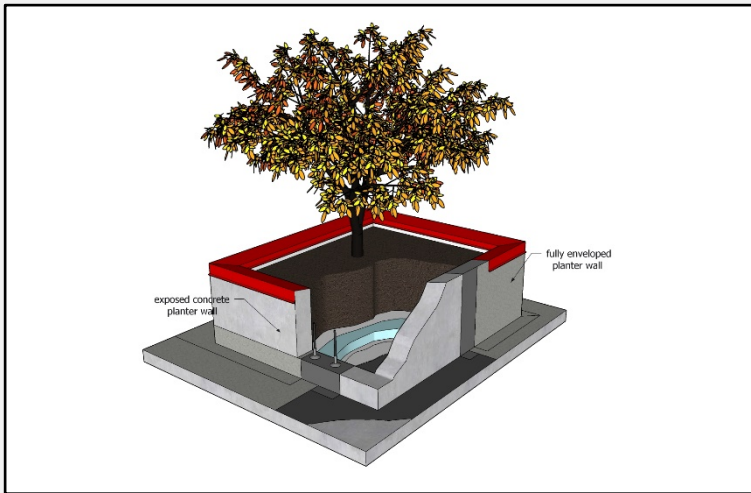

- 4) Dowels (reinforcement bar) must be
 - 1) inserted into the pre-curb after application of the membrane flashing.
 - 2) waterproofed in their final position, where they penetrate the pre-curb, using either a reinforced 2-part liquid membrane flashing or two (2) applications of a single-component liquid membrane flashing (fully cured between coats),
 - 1) applied to properly prepared surfaces.
 - 2) in keeping with the application standards in **11.3.3.3 Liquid Membrane Flashing** for 2-part reinforced liquid membrane flashing, or the manufacturer's instructions for single-component liquid membrane flashing.
 - 3) applied no less than 50 mm (2") on vertical surfaces and in a radius around the base of each dowel.
 - 5) Structural planters and water features constructed on pre-curbs must be waterproofed on the inside with a fully-adhered membrane that terminates on the inside vertical surface of the planter at least 100 mm (4") above the level of soil, growing medium or water, or at the outside edge of the top surface of the planter or water feature wall.
 - 6) Membranes must be terminated in keeping with the standards in **Part 11 DRAINS and PENETRATIONS** and protected with metal reglet or cap flashings in keeping with **Part 13 METAL FLASHINGS**.
 - 7) A membrane integrity scan and any resulting repairs must be undertaken before the membrane is covered or submerged.
-