

# RoofStar Guarantee Standard for Asphalt Shingle Systems

## How to use this Standard

This Standard is comprised of fourteen (14) Parts that contain the Standards, Guiding Principles, Recommendations and Reference materials necessary for the design and installation of a *Project* to qualify for a **RoofStar 5-Year Guarantee** or **RoofStar 10-Year Guarantee**.

Readers are advised to review relevant materials that can be accessed through the hyperlinks embedded in the body of text and visible in **blue**. Part titles shown in blue indicate hyperlinks to more relevant material that the reader is advised to consult.

Content in each Part is colour-coded according to four classes, to assist the reader in understanding:

**Standards**

**Guiding Principles**

**Recommendations**

**Reference materials**

For definitions of these terms of reference, click [here](#).

## Editor's note

Please note that the PDF highlights only the changes made since the last published revision of these Standards.

The reader is responsible to ensure that downloaded copies remain current with the online version of the Roofing Practices Manual. Only the online version of these or any other **RoofStar Guarantee Standards** shall be considered valid for the purpose of designing and constructing a RoofStar-qualified Project.

For all changes made since the last major revision (October 2019), consult the official online version of this Standard. In the event of a discrepancy between this PDF and the official online version of this Standard, the official online version shall be used.

This Standard was revised on **February 5, 2021** and replaces the Standard dated October 30, 2020.

# 1 GENERAL

## 1.1 References

In this *Manual*, all references to

- 1) the *British Columbia Building Code*, municipal or regional building codes or regulations (collectively referred to as the “Code”), or other standards, presume the current edition that is in force.
- 2) materials are assumed to be Accepted by the RGC, unless stated otherwise.

## 1.2 Definitions

### **Assembly**

means a *system* in combination with its *supporting deck* structure (adapted from *ASTM D6630-08 Standard Guide for Low slope Insulated Roof membrane Assembly Performance*).

### **Contractor**

means the installer of a *project*. For the purpose of issuing a **RoofStar Guarantee**, *Contractor* shall be read to mean an Active Member of the RCABC.

### **Design Authority**

means the individual or firm responsible for the issuance of *project* specifications and details to which the *project* will be bid and constructed. When a *Contractor* designs a *project*, the *Contractor* is deemed to be the *Design Authority*.

### **Eave protection**

means a self-adhering water-proofing underlayment of a *water-shedding system* that is applied along the eaves to prevent water ingress. Eave protection materials may also be applied in valleys or along vulnerable plane transitions.

### **Finished waterproofing/water-shedding system**

means the top surface of a *waterproofing system* or *water-shedding system* that may include ballast or that supports *overburden*.

### **Guarantor**

means the RGC **RoofStar Guarantee Program** that issues the **RoofStar Guarantee** (“*Guarantee*”); the two terms may be used interchangeably.

### **Linear metal flashings**

are flashings cut and shaped from flat metal stock, to redirect water at roof perimeters and edges, and are used in valleys and drainage spillways.

### **Manual**

means the **Roofing Practices Manual**.

### **Project**

means the scope of work for which the *Contractor* is responsible.

### **System**

means the organization and securement of various interacting materials (apart from the *supporting deck* structure), designed and installed to prevent the transmission of water through the *system* into the conditioned space of a building (adapted from *ASTM D6630-08 Standard Guide for Low slope Insulated Roof membrane Assembly Performance*).

### **Underlayment**

means a sheet material, either self-adhered or mechanically fastened, which serves as secondary protection beneath the water shedding roof covering of a *water-shedding system*.

### **Waterproofing system**

means a sheet membrane or liquid-applied *system* that, regardless of slope, excludes water from a building and therefore waterproofs it. These systems are typically installed on slopes less than 1:4 (3" in 12"), on roofs or at grade level.

### **Water-shedding system**

means a *roof system* that, with sufficient slope, sheds water away from a structure but does not necessarily waterproof it.

Refer to the [Glossary](#) for further definitions of key terms used in this Standard.

## 1.3 Design

### 1.3.1 [NOT USED]

### 1.3.2 General

- 1) Asphalt shingles are intended for roof slopes 1:6 and greater.
- 2) When a roof is designed and constructed so that the resulting roof slope is less than 1:6 (as, for example, dead valleys and the roof areas below a dormer), the roof area must be designed as a *waterproofing system*.
- 3) When asphalt shingles drain into a membrane gutter, refer to **12.2 Built-in Membrane Gutters**.

### 1.3.3 High Snow Conditions

- 1) In this Standard, a *high snow load area* is considered a regional area with a Specified Snow Load higher than 3.5 kPa.
- 2) To determine if a building is located in a high snow load area, the *Design Authority* must calculate the anticipated snow loads for the roof, using the building code having jurisdiction. The following references are extracted from the *British Columbia Building Code*:
  - 1) *Div. B, 4.1.6.2 Specified Snow Load* (see the formula for calculating snow loads).
  - 2) *Div. B, Appendix C, Table C-2* which lists various types of loads, including snow loads, for specific reference locations throughout the province.
- 3) Roofs subject to high snow loads must be designed with a supporting deck structure thick enough to support the anticipated live loads, within the acceptable deflection limits defined by the *British Columbia Building Code*.
- 4) Consideration should be given to
  - 1) slope.
  - 2) entrances and exits.
  - 3) penetrations.
  - 4) valley construction.
  - 5) proper intake and exit ventilation irrespective of snow cover and drifting.
  - 6) penetrations and their functionality.

### 1.3.4 [NOT USED]

### 1.3.5 Hot Works: Design

When any portion of a *waterproofing system* is installed with heat, the work is classified as Hot Works. Some tools used in the course of Hot Works can ignite combustible materials, and some building environments are more sensitive to fire than others, such as a building containing, or close to, flammable liquids. Hot Works may occur during

- tear off (sparks).
- deck preparation (drying wet surfaces).
- cold temperatures (warming materials or surfaces).

- equipment use (sparks within electrical tools, or from cutting, drilling or grinding metal, concrete, stone or other hard surface products).
  - membrane installation (with the means of a kettle, hot-air welder or open flame torch).
- 1) **The *Design Authority* may specify that the *Contractor* must maintain compliance with the RCABC Hot Works Program and consequently manage the Hot Works conducted on site.**
  - 2) When the *project* involves Hot Works, the *Design Authority* must either
    - 1) pre-approve alternate applications already written in this Standard or another applicable Standard published in this *Manual*, when the specified application is deemed to be fire-sensitive by the *Contractor* as part of the risk assessment process, or
    - 2) provide alternate material and application requirements in the specification for fire-sensitive locations on the *project*.

See also **1.4.3 Hot Works: Contractor Requirements.**

### 1.3.6 Variances

When a design is unable to conform to the Standard, the *Design Authority* may apply to the RGC for a written Variance. Application must be made in writing (email correspondence is common), and the request must

- 1) identify the *project* name, its civic address and the applicable **RoofStar Guarantee** number (if already initiated).
- 2) articulate the nature of the design problem.
- 3) cite the **RoofStar Guarantee** standard reference to which the Variance will apply.
- 4) provide design drawings (and photographs, if available) as supporting information.

We may ask for more information in order to fully consider a request for a Variance and will issue a completed Variance only to the *Design Authority* for distribution to the *Contractor*.

A Variance may be unrestricted in its scope, or it may include one or more conditions that will affect the design and construction of the *water-shedding system* or *waterproofing system*, in order to accommodate the varied standard. Occasionally, a Variance may also restrict coverage offered by the **RoofStar Guarantee**.

Variances are issued only for the specific issue on the *project* identified in the written request, and do not constitute general permission to depart from the published requirements in this Standard, for any aspect of the same *project* or for future *projects*, designed or constructed by any other firm.

## 1.4 Scope

- 1) The **Guarantee Standards**, Guiding Principles, Recommendations and Reference Materials in this Standard pertain to both new roofing construction and replacement roofing, unless explicitly stated otherwise.

### 1.4.1 New Construction

- 1) New roof construction must utilize only newly manufactured materials, and may not incorporate recycled products, unless with the expressed, written consent of the **Guarantor**.

### 1.4.2 Replacement Roofing and Additions

- 1) Replacement roofing shall be undertaken in the same manner, and to the same standards, as new roofing and must be installed over a bare, clean and suitable deck, free of any other materials (with the exception of existing eave protection membrane; refer below in this subsection), knots, distortions or ridges. Roofing over existing shingles is not permitted.
- 2) Existing self-adhered eave protection membrane may be left in place but must be covered with a new layer of RoofStar-accepted membrane, in keeping with the requirements in this Standard.

- 3) New shingles and existing rainwater gutters must be protected from incidental damage including, without limitation, damage caused by ladders.
- 4) Where a new roof is tied-in to an existing roof, the two areas must be isolated and separated by a curb joint properly constructed a minimum height of 125 mm (5”), attached to the structure and properly flashed.
- 5) When replacement roofing is complete, debris must be removed from rainwater gutters.

### 1.4.3 Hot Works: Contractor Requirements

- 1) The *Contractor* must maintain the requirements of the RCABC Hot Works Program. This includes the following, without limitation:
  - 1) **Insurance Coverage** – limits carried on the *Contractor’s* policy must equal or exceed the minimum requirements set by RCABC, and coverage must be unhindered by warranties that limit or exclude coverage when Hot Works is required.
  - 2) **Education and training** – workers who perform Hot Works must be trained by the *Contractor* and kept current with acceptable methods.
  - 3) **British Columbia Fire Code** – a Fire Safety Plan, preventative methods or alternative work procedures, fire watches, and the use and placement of equipment at the *project* site must comply with the *British Columbia Fire Code* requirements for Hot Works.
  - 4) **Fire Safety Plan** – the *Contractor* must assess the hazards to property and persons and produce a written Fire Safety Plan prior to the start of work. The Fire Safety Plan must be kept on the *project* site and must be kept current until the *project* is completed.
  - 5) **RoofStar Guarantee Standards** – the *Contractor* must adhere to the **RoofStar Guarantee Standards** at each juncture where the interface of different membranes applications constitutes part of the Fire Safety Plan.
  - 6) **Fire Watch** – the *Contractor* must, as part of the Fire Safety Plan, conduct a fire watch
    - 1) that complies with the *British Columbia Fire Code*.
    - 2) assigned to competent, trained personnel using suitable equipment including the use of a hand-held infrared thermometer.
    - 3) documented in a written fire watch log.
  - 7) **Hot Works Notification** – notify the *project* authority or the AHJ, as and when required, that Hot Works will be performed.

## 1.5 Workmanship

While integrity and functionality of a new roof or grade-level waterproofing is the foundation of a **RoofStar Guarantee**, it is no less important to ensure that the end finished *project* exhibits excellent workmanship. Therefore, the following standards apply:

- 1) The *Contractor* must take reasonable measures to protect the *project* from damage by the weather, during and at the completion of **the project**. Open penetrations and flashings must be temporarily sealed off from the weather, even when other trades are responsible to make a permanent seal or install overlapping materials. See also **4.2 General**.

### 1.5.1 [NOT USED]

## 1.6 RoofStar Guarantee: Coverage and Limitations

A **RoofStar Guarantee** is available for almost any roof design, provided its design and construction conforms to this Standard. Nevertheless, there are limitations and conditions. They are listed on the **Guarantee** certificate, and include (without limitation) the following (as they are applicable to the type of *project*):

- 1) The **RoofStar Guarantee** covers leaks resulting from new materials purchased, supplied and installed by the *Contractor*. All new materials incorporated into a *project* intended to qualify for a **RoofStar Guarantee** must

be expressly accepted by the RGC and listed in the **Roofing Practices Manual**. Accepted Materials include (without limitation)

- 1) *Primary* and *Secondary Materials*.
- 2) penetration flashings and drains.
- 3) roof-related linear metal flashings.

All materials or products supplied by anyone other than an Associate Member of the RCABC, or which are installed by someone other than the *Contractor*, will be excluded from coverage under the **Guarantee**, and may void the **Guarantee** entirely.

- 2) Notwithstanding the definition of a *waterproofing system* or *water-shedding system*, the **RoofStar Guarantee** does not cover the quality, installation or performance of the *supporting deck*.
- 3) The **RoofStar Guarantee** (subject to the limitations described herein or stated on the **Guarantee** certificate) is a guarantee against leaks only, caused only by a failure of new materials installed by the *Contractor*, or resulting from the *Contractor's* installation of new materials.

The term "new materials" includes *Primary* and *Secondary Materials*, *linear metal flashings*, and both penetration flashings and roof drains that have been expressly accepted for use on a *project* designed and constructed to qualify for a **RoofStar Guarantee**. Only materials listed in the Accepted Materials Division of the **Roofing Practices Manual** qualify for a **RoofStar Guarantee**.

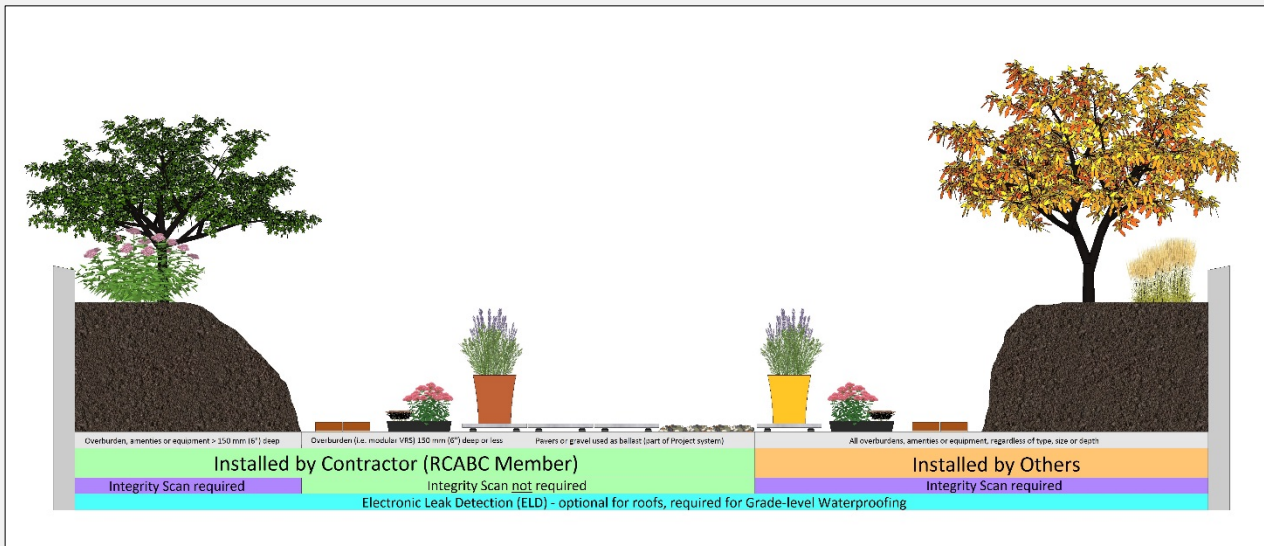
The re-use of any existing material on a *project* may void the **Guarantee**.

- 4) Notwithstanding any of the *Guarantee* requirements in this *Manual*, a **RoofStar Guarantee** will not cover
  - 1) leaks resulting from
    - 1) improper design.
    - 2) overloading.
    - 3) water entry from other building components (*walls*, skylights, etc.).
    - 4) the failure of a drain or flashing supplied or installed by anyone other than the *Contractor*.
    - 5) neglected maintenance of the *Project*.
    - 6) building air leakage.
    - 7) modifications to the *project* made by anyone other than the *Contractor*.
    - 8) changes in building use or occupancy.
  - 2) drain leaders, which are not considered part of the *roof system*.
  - 3) the costs to remove and reinstall irrigation or other services (including, without limitation, electrical and gas services).
  - 4) replacement (new for old) of any *overburden*.
  - 5) damage or leaks caused by the roots of invasive plant species (for example, certain varieties of bamboo or willow), regardless of measures taken to protect the membrane.
  - 6) a sacrificial third ply or a coating, used as a walkway or warning zone, which is not considered part of the *roof system*.
- 5) *Overburdens* may be installed on a *Conventionally Insulated Waterproofing System* or *Protected ("inverted") Membrane Roof Assembly*, but not all designs are suitable for any type, size or depth of *overburden* (see **Part 14 THE ROOF as a PLATFORM** in *Waterproofing Systems* standards). **The RGC recommends that a roof supporting overburden be designed and constructed as a Protected Membrane Roof Assembly**. The **RoofStar Guarantee** may be void if a roof is designed and constructed with *overburden* that exceeds the capabilities of a *Conventionally Insulated Waterproofing System*.
- 6) Only a fully adhered membrane may be used in a *Protected ("inverted") Membrane Roof Assembly*.
- 7) **Integrity Scans**: An Integrity Scan
  - 1) must be performed by an RGC-recognized service provider listed in this *Manual*.

- 2) is required on all *Waterproofing Systems*, to ensure the waterproofing is leak and damage-free, when *overburdens*, amenities or equipment are or will be installed on the completed *Waterproofing System* by
  - 1) anyone other than the *Contractor*.
  - 2) the *Contractor* but only when
    1. the total *project area* (footprint), inclusive of planters or other waterproofed features, exceeds 18.58 m<sup>2</sup> (200 sf), and
    2. the *overburdens*, amenities or equipment exceed 150 mm (6") in depth.
- 3) is not required when the *Contractor* installs *overburden*, amenities or equipment
  - 1) equal to or less than 150 mm (6") in depth.
  - 2) the total *project area* (footprint), inclusive of planters or other waterproofed features, is less than 18.58 m<sup>2</sup> (200 sf), but the *Contractor* must nevertheless protect all membrane-covered surfaces (including walls and parapets) with RoofStar-accepted protection materials immediately after the membrane is installed.

See **Figure 1.1** for further reference.

**Figure 1.1**



- 8) **Electronic Leak Detection** is mandatory for grade-level *Waterproofing Systems*, but optional for roof *Waterproofing Systems*.
- 9) **Pre-curbs and Concrete Features**
  - 1) When concrete *walls* or structures are constructed without a pre-curb, all concrete surfaces must be fully and continuously enveloped with the primary roof membrane.
  - 2) While the application of non-penetrating bonded tiling or other architectural finishes to the waterproofing membrane is acceptable for a **RoofStar Guarantee**, and is subject to approval by the membrane manufacturer, the removal, reinstallation or replacement of any bonded finish, in order to investigate and repair leaks under the terms of the **Guarantee**, is the responsibility of others.
- 10) **Modifications during the Guarantee Term**
  - 1) The **Guarantor** must be notified in writing of any modifications or repairs to the RoofStar-guaranteed *project*.
  - 2) The building owner must ensure that any modifications or repair work done on the *project* during the guarantee period is performed to **RoofStar Guarantee Standards** by a *Contractor* and is inspected by a RoofStar-accepted observation firm.

- 11) **Maintenance:** the building Owner must ensure that the *Project* and its components are properly maintained. Debris in drains, caulking on or around metal flashings, and wind scouring of gravel are considered maintenance issues.
  - 12) **Removal and Reinstallation of Overburdens:** in order to investigate and repair a leak, the **RoofStar Guarantee Program** must be allowed to remove *overburdens*, to expose the membrane. The **RoofStar Guarantee** pays for the removal and reinstallation of accessible *Overburdens* only (subject to the limits published below), when they are installed by the *Contractor*, regardless of the *project* design. The cost to remove, care for and reinstall any *overburden* that exceeds these limits or conditions, which is *inaccessible* or which was supplied or installed by others, will be borne by the building owner.
    - 1) **Maximum coverage area:** limited to one physically defined *project* area (no maximum size).
    - 2) The **RoofStar Guarantee** pays for removal and reinstallation of accessible *overburdens* up to the following limits:
      - 1) *Extensive vegetated roof systems*, provided they are comprised of trays or other recognized modular methods and are less than 150 mm (6") in depth, exclusive of the plants.
      - 2) other accessible coverings, provided they are unitized (for example, pavers on pedestals) and do not exceed 1 M2 or 90 Kg (200 lb.) per unit.
      - 3) gravel ballast and its associated drainage or protection material components, provided the ballast is less than 150 mm (6") deep.
      - 4) structures, furnishings or planters provided each item, or any single component of each item, is easily detachable, does not require a specialty trade, and is no heavier than 90 Kg (200 lb).
-



## 2 SUPPORTING STRUCTURES: Decks and Walls

### 2.1 General

#### 2.1.1 Definitions

Refer to the [Glossary](#) for further definitions of key terms used in this *Manual*.

**Supporting deck** (“deck”)

means the structural surface to which the *waterproofing system* or *water-shedding system* is applied (adapted from *ASTM D1079-18 Standard Terminology Relating to Roofing and Waterproofing*).

**Deck overlay**

means a panel material secured to the *supporting deck*, to render the *deck* surface continuous or suitable for the installation of roofing materials.

**Wall**

means a structural or non-structural element in a building that vertically separates space. *Walls* may separate the outside environment from the interior conditioned space of a building, or they may separate one or more interior spaces from each other (adapted from *ASTM E631-15 Standard Terminology of Building Constructions*).

**Wall overlay**

means a panel material secured to the surface of a *wall*, to render it suitable for the installation of roofing or *wall* cladding materials.

#### 2.1.2 Design

- 1) The Code having jurisdiction prevails in all cases except where it is exceeded by the requirements published in this Standard.
- 2) Notwithstanding the requirements in this Standard, the **RoofStar Guarantee** does not extend coverage to the *supporting deck* or to its securement, which is the responsibility of the *Design Authority* and the building contractor.
- 3) Prior to the application of the *roof system*, the *supporting deck* and other surfaces receiving membranes must be smooth, straight, clean and free of
  - 1) moisture.
  - 2) frost.
  - 3) dust and debris.
  - 4) contaminants.
  - 5) objectionable surface treatments.
  - 6) release oils.
  - 7) laitance.

If surface drying is required prior to roofing, use blown air to facilitate this.

- 4) *Walls, parapets, curbs, blocking and penetrations should be constructed or placed prior to the commencement of roofing work. This work is provided by other trades.*
- 5) *The supporting deck should be dimensionally stable and capable of accommodating roof system component movement.*

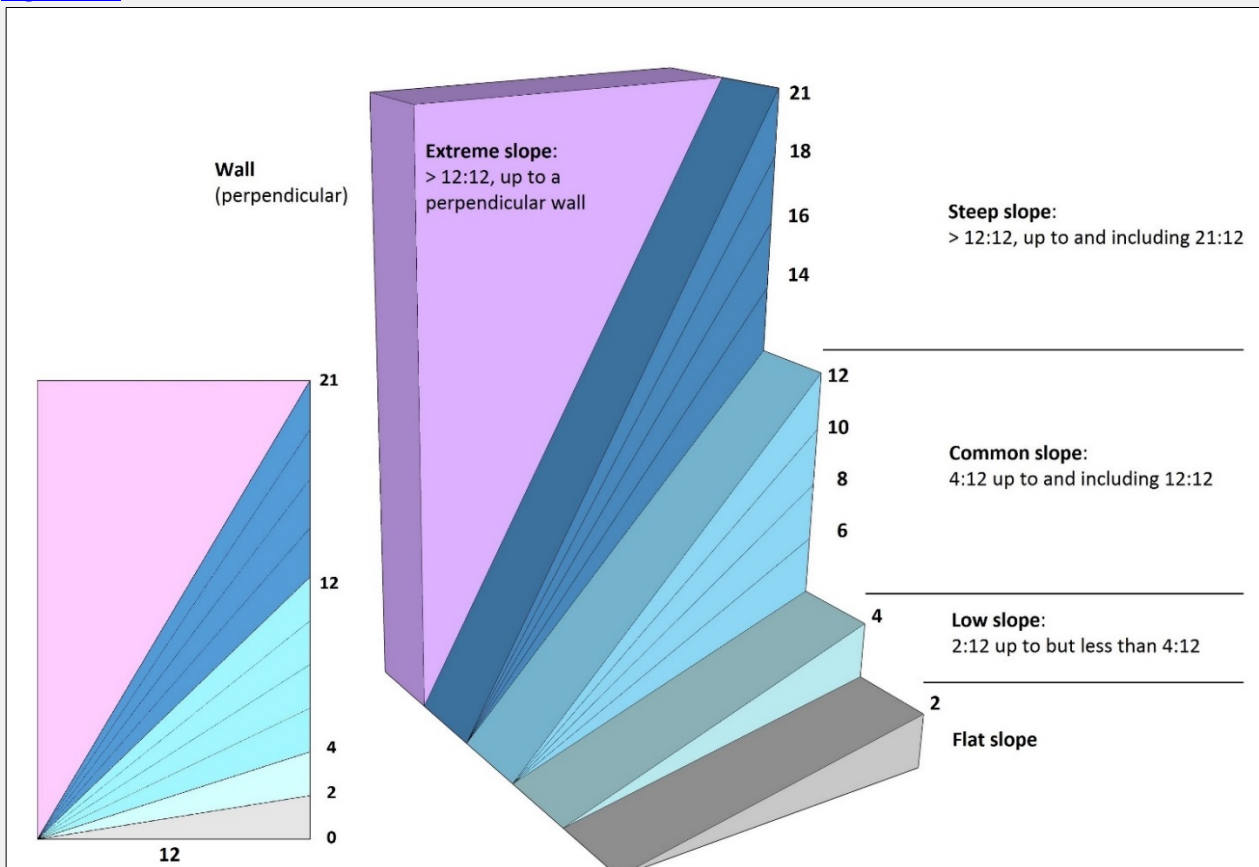
### 2.2 Roof Slope

- 1) The **RoofStar Guarantee Program** classifies *roof systems* according to their function – *waterproofing systems* or *water-shedding systems*. Within each classification, slope is defined as follows:
  - 1) **Flat** means a roof with a slope less than 1:6 (2” in 12”, or 9 degrees).

- 2) **Low Slope** means a roof with a slope from 1:6 (2" in 12", or 9 degrees) up to but less than 1:3 (4" in 12", or 18 degrees).
- 3) **Common Slope** means a roof with a slope 1:3 (4" in 12", or 18 degrees) up to and including 1:1 (12" in 12", or 45 degrees).
- 4) **Steep Slope** means a roof with a slope greater than 1:1 (12" in 12", or 45 degrees) up to and including 21:12 (21" in 12", or 84 degrees).
- 5) **Extreme Slope** means a roof with a slope greater than 21:12 (21" in 12", or 84 degrees).

See **Figure 2.1** for an illustrated guide to the above definitions.

**Figure 2.1**



## 2.3 Supporting Deck Types

### 2.3.1 General

- 1) All *supporting decks* must provide a suitable nailing substrate for asphalt shingles and be acceptable to the shingle manufacturer. Suitability includes, without limitation,
  - 1) sufficient thickness for fastener holding.
  - 2) stiffness that minimizes *deck* deflection.
- 2) Prior to the application of the roof system, the supporting deck structure (roof deck) and other surfaces receiving membranes must be smooth, straight, clean and free of
  - 1) moisture.
  - 2) frost.
  - 3) dust and debris.

- 4) contaminants.
- 5) objectionable surface treatments.
- 6) release oils.
- 7) laitance.

If surface drying is required prior to roofing, use blown air to facilitate this.

- 3) *Walls, parapets, curbs, blocking and penetrations should be constructed or placed prior to the commencement of roofing work. This work is provided by other trades.*
- 4) *The supporting deck should be dimensionally stable and capable of accommodating roof system component movement.*

## 2.3.2 Wood Decks

### 2.3.2.1 All Projects

- 1) Wood *decks* shall be constructed of plywood that is
  - 1) at least 12.7 mm (½") thick.
  - 2) securely fastened to supports with spiral nails at least 50 mm (2") in length.
- 2) All plywood decking (sheathing) must be securely fastened to structural supports with ring-shanked nails having a shank at least 3 mm (1/8") thick and a head at least 9.5 mm (3/8") in diameter. Fasteners must penetrate structural material at least 19 mm (3/4").
- 3) Oriented Strand Board (OSB) and other non-veneered panels are acceptable *deck* materials, but the *Design Authority* is responsible to determine the grade and thickness in order to meet the required pull-out resistance for the expected fasteners.
- 4) Shiplap and dimensional lumber are not acceptable *deck* materials.
- 5) Knotholes and cracks in *decks* shall be considered defects and must be covered with sheet metal nailed in place.

### 2.3.2.2 Replacement Roofing

- 1) Plywood used as an overlay on existing *roof decks* must be at least 12.7 mm (1/2") thick and must conform to *CSA 0151-04, Canadian Softwood Plywood, Grade C or better; or CSA 0121-M 1978 (R2003) Douglas Fir Plywood, Grade C or better.*
- 2) When an existing roof *deck* is
  - 1) less than 12.7 mm (1/2") thick, or is constructed of shiplap or dimensional lumber, it must be overlaid with new plywood that
    - 1) is properly secured to structural supports.
    - 2) provides sufficient material depth for fastener penetration.
  - 2) constructed with damaged or excessively cupped shiplap or dimensional lumber (excessive cupping is considered 25 mm (1") or more when measured against the mid-span deflection of the *deck*), the damaged or distorted material must be removed and replaced with new material.

See also **Part 5 DECK and WALL OVERLAYS.**

- 3) When cedar or tiles, supported by spaced strapping or board *decks* (plank, mill, or shiplap), are replaced with asphalt shingles,
  - 1) the existing strapping or *decking* must be overlaid with plywood
    - 1) conforming to the requirements in this Standard.
    - 2) oriented either horizontally or vertically, unless otherwise required by the AHJ.
    - 3) staggered at least 400 mm (16"), or in conformity with truss or rafter spacing.
    - 4) spaced no less than 2 mm (3/32") between panels, on all sides.
    - 5) supported fully by the strapping along the long edges of the plywood.
  - 2) plywood *deck overlays* must be secured in keeping with the *British Columbia Building Code, Division B, 9.23*), but in any event shall not be less than 23 fasteners
    - 1) spaced no more than 150 mm (6") O.C. along the edge.

- 2) spaced no more than 300 mm (12") O.C. in the field.
- 3) clearance to all "hot" pipes must conform to the requirements set out in the Code.

### 2.3.3 Steel Decks

- 1) Steel *decks* are not suitable for asphalt shingle application and therefore must be overlaid with a sub-deck that permits ventilation below the sub-deck. Sub-deck sheathing must meet the minimum requirements for wood *decks* (See **2.2.1 Wood Decks**).

## 2.4 [NOT USED]

## 2.5 [NOT USED]

## 2.6 Walls

### 2.6.1 General

- 1) *Wall* surfaces must provide a be clean, dry and smooth, vertical surface suitable for the application of *roof system* materials. When the *wall* surface is unsuitable to receive waterproofing materials, it must be resurfaced with an RGC-accepted *wall overlay*. See **Part 5 DECK and WALL OVERLAYS** for material and application standards.
- 2) *Sheathing*, defined as a rigid panel material secured directly onto framing, is considered a *wall* surface for the purpose of this Standard.
- 3) *Wall* surfaces receiving waterproofing materials must extend vertically beyond the maximum height of waterproofing materials but in any event must be at least 200 mm (8") high, above the surface of the *finished water-shedding system*. For suitable *wall* surface materials, see **2.6.2** below.
- 4) *Walls and roofs commonly intersect in two ways*:
  - 1) *Directly, where the wall structurally connects to the roof structure, so that both move together.*
  - 2) *Indirectly, where the roof structure and the wall structure are independent of each other, so that the movement of one does not affect the other.* These locations require an expansion joint.
- 5) The *Design Authority* must ensure a continuous connection between the *roof system* from field to perimeter, in order to control or inhibit the movement of water, air and vapour.
- 6) Wood or steel-stud *walls* must be sheathed with a material suitable for securing *linear metal flashings*.
- 7) For concrete *walls*, refer to **2.2.3 Concrete** above.

### 2.6.2 Material

- 1) Concrete surfaces must comply with the requirements set out in **2.1 (3)**. When concrete surfaces do not comply, concrete *walls* may be sheathed with any one of the following:
  - 1) 15.9 mm (5/8") thick treated plywood.
  - 2) fibre-mat reinforced cement boards with a minimum thickness of 9.5 mm (3/8").Both materials must also conform to *ASTM C1325-04*.
- 2) For framed *walls*, the following *sheathing* material are acceptable:
  - 1) Moisture resistant fibreglass-faced silicon treated gypsum core board specifically designed to receive roof membranes; boards must have a minimum thickness of 12 mm (1/2"). These panel may be installed horizontally or vertically.
  - 2) Fibre-mat reinforced cement boards with a minimum thickness of 9.5 mm (3/8").
  - 3) Plywood with a minimum thickness of 12 mm (1/2").

## 2.7 Electrical Cables and Boxes

Electrical cables (including conduit) or boxes installed inside, on top of, or beneath a roof assembly expose roofing workers to electrical shock, and may inhibit the installation of some *roof systems* designed to resist wind uplift. Furthermore, electrical cables on, in or under the *roof assembly* expose the building and the public to both shock and

fire. Hidden electrical wiring and boxed junctions can be extremely difficult to document before work begins, and while some technologies are purportedly accurate in identifying energized circuits before they are damaged, false readings make these technologies less than reliable. During replacement roofing, avoiding damage to electrical circuits from cutters and fasteners is sometimes next to impossible. It is therefore desirable to design buildings with realistic separations between electrical wiring and boxes, and *roof assemblies*.

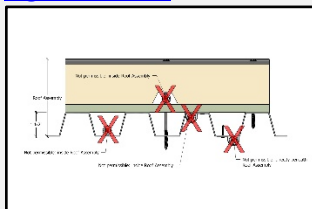
For more about this topic, see the [Information Bulletin](#) reissued by **Technical Safety BC** (formerly **BC Safety Authority**) June 2020.

Currently, neither the *Canadian Electrical Code, Part I* nor the *British Columbia Electrical Code* explicitly prohibit, nor explicitly permit, the installation electrical cables and boxes anywhere in close proximity to a *roof assembly*. The *Design Authority* therefore has the latitude to write restrictions concerning the location of electrical installations, and consequently eliminate shock and fire hazards. To do so, apply the following standards when preparing *Project specifications* to qualify for a **RoofStar Guarantee**.

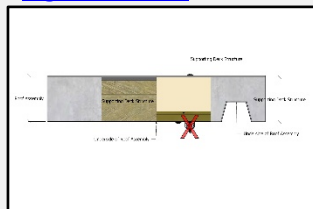
## 2.7.1 New Construction

- 1) Electrical cables, raceways or boxes shall not be installed within a *roof assembly* (**Figure 2.7.1-1**).
- 2) Electrical cables, raceways or boxes shall not be installed on the underside of a *roof assembly*, unless
  - 1) the *supporting deck* structure equals or exceeds 76 mm (3”) in thickness (**Figure 2.7.1-2**), or
  - 2) the cables, raceways or boxes are installed and supported so there is a separation of not less than 38 mm measured between the underside of the *roof assembly* and the electrical installation (**Figure 2.7.1-3**).
- 3) Notwithstanding either (1) and (2), cables or raceways shall be permitted to pass through a *roof assembly* for connection to electrical equipment installed on the roof, provided that the passage through the roof is a part of the *roof assembly* design.
- 4) Electrical cables installed above the *roof assembly* should be elevated to permit proper support, roof maintenance and future replacement roofing (**Figure 2.7.1-4**).

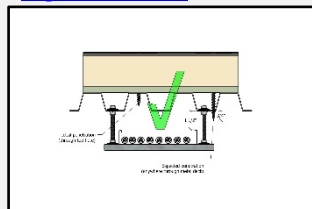
**Figure 2.7.1-1**



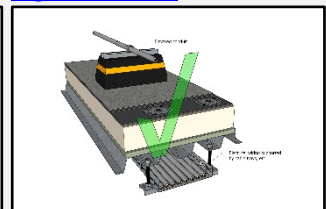
**Figure 2.7.1-2**



**Figure 2.7.1-3**



**Figure 2.7.1-4**



## 2.7.2 Replacement Roofing

- 1) If existing electrical cables or boxes do not conform to the standards in **2.6.1 New Construction**, the *Design Authority* must consider the attachment of the *roof system* above the electrical system, and the requirements set out in **Part 3 SECURING the ROOF ASSEMBLY**.
- 2) The *Design Authority* should
  - 1) specify protection of existing electrical cables and boxes (a 5 mm (3/16”) steel plate may be used to minimize the possibility of fastener penetration and cutter damage, but it should be understood that protection plates may interfere with mechanical fasteners used to secure the *roof system* against wind uplift, even for future replacement roofing).
  - 2) provide the building owner with detailed as-built drawings that accurately map the location of electrical cables and boxes.

## 3 SECURING the ROOF ASSEMBLY

### 3.1 General

#### 3.1.1 Design and Testing

- 1) Asphalt shingles shall be installed to resist wind, in conformity with *CSA A123.51 Asphalt shingle application on roof slopes 1:6 and steeper*, or as specified by the shingle manufacturer, whichever requirement is greater.

### 3.2 Materials

#### 3.2.2 Fasteners and Adhesives

The following minimum standards apply to any *roof system*, regardless of requirements published elsewhere.

- 1) Fasteners and adhesives must be capable of securing the *roof system* components to resist uplifting wind loads.
- 2) *The Design Authority should specify the correct type of fastener, keeping in mind*
  - 1) pull-out strength.
  - 2) corrosion resistance (contributing factors to fastener corrosion may include dissimilar metal contact, excessive building humidity, corrosive chemicals within components of the assembly, or corrosive elements provided within the building envelope etc.).
- 3) Nails (gunnable or hand-driven) for field and hip and ridge shingles must be
  - 1) manufactured in conformity to *CSA B111*.
  - 2) corrosion resistant (hot-dipped or stainless steel).
  - 3) at least 2 mm (12 Ga.) thick in the shank, with large 9.5 mm (3/8") heads.
  - 4) of sufficient length to penetrate through, or at least 19 mm (3/4") into, the roof *deck* (sheathing).
- 4) Staples may not be used to secure asphalt shingles.
- 5) Cladding Screws must be
  - 1) No. 8 (1/8") gauge or larger.
  - 2) fitted with a rubber gasket.
  - 3) compatible with, and corresponding in colour to, metal flashing material.
- 6) When the roof system incorporates an insulation *assembly* on the exterior side of the *supporting deck*, self-drilling screws with recessed heads must be used in combination with plates as follows:

**Table 3.1 Minimum Fastener and Plate Requirements**

Material	Fastener Size	Plate
Deck overlays	#12	73 mm (2-7/8") Hexagonal, 76 mm (3") Round or Square
Insulation	#12	73 mm (2-7/8") Hexagonal, 76 mm (3") Round or Square
Insulation Overlays	#12	73 mm (2-7/8") Hexagonal, 76 mm (3") Round or Square
Membranes	#14	Proprietary

- 7) For adhered and partially adhered *systems*, adhesives must be acceptable to the manufacturers of the *roof system* components.
- 8) Bitumen is not typically used as an adhesive for insulation and other components on *water-shedding systems*, but if it is specified, it must be Type 3 or SEBS. Pay attention to the slope limitations specified by the manufacturer of the product.

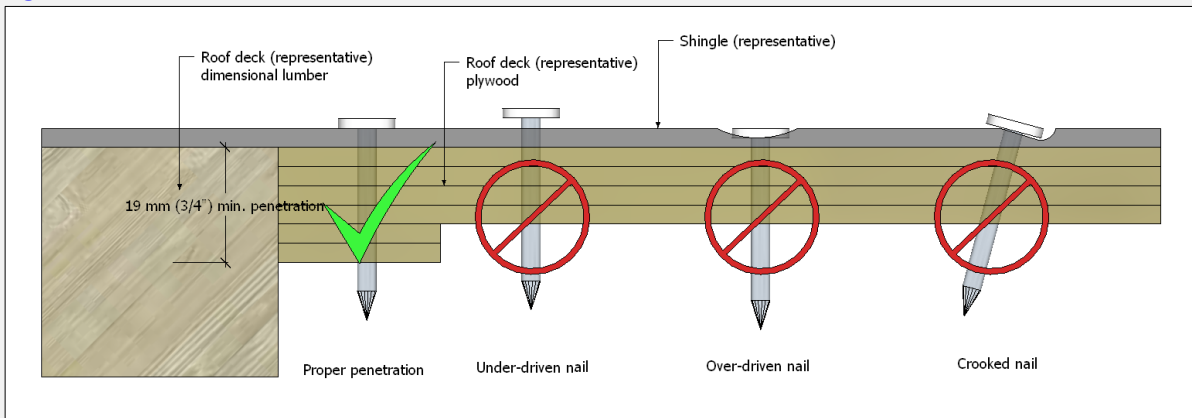
### 3.3 Application

- 1) Mechanically fastened underlayments must be installed with fasteners approved by the product manufacturer.

- 2) All asphalt shingles must be nailed within the shingle manufacturer's designated fastening zone or line. Nailing outside of the fastening zone or line is not permitted. See also **9.3.1 General** for asphalt shingle securement requirements.
- 3) Nail penetration into or through the *deck* must be at least 19 mm (¾") when measured from the top face of the *deck*.
- 4) Only nails driven perpendicular to the shingle and *supporting deck* surface shall be deemed acceptable.
- 5) Nails must be driven
  - 1) perpendicular to the surface of the *deck*, and must not be under-driven, over-driven or crookedly driven.
  - 2) into or through the *deck* at least 19 mm (¾") when measured from the top face of the *deck*.

See **Figure 3.1**.

**Figure 3.1**



- 6) When threaded fasteners are used to secure another material to a substrate, mechanical fasteners must penetrate
  - 1) steel *decks* at least 20 mm (¾") – fasteners should penetrate the top flutes only.
  - 2) into solid dimensional lumber by at least 25 mm (1").
  - 3) through plywood sheathing by at least 19 mm (¾").

These standards may be exceeded by the fastener manufacturer's published requirements.

- 7) On *Low Slopes* and *Common Slopes* (up to 1:1 (12" in 12")), at least four (4) nails for each full shingle shall be used.
- 8) On *Steep Slopes* (1:1 (12" in 12") up to and including 21:12), at least 6 nails for each full shingle shall be used.
- 9) Notwithstanding any nailing patterns specifically accepted by the **RoofStar Guarantee Program**, shingles installed on *Extreme Slopes* (slopes greater than 21:12) shall be
  - 1) fastened with at least 6 nails per full shingle shall be used, consisting of 1 nail at each end of the shingle and double nails at each third point.
  - 2) manually cemented in place underneath each tab, immediately after installation, using a spot of asphalt plastic cement approximately 22 mm in diameter that is located at the centre of each shingle tab. This may be exceeded by manufacturer's requirements.
- 10) When partial shingles (segments), ridge or hip caps are installed, each shall be fastened
  - 1) with at least two (2) nails set in from either edge by 25 mm (1").
  - 2) with nails set no more than
    - 1) 325 mm (13") apart, when installed on slopes up to and including 1:1 (12" in 12").
    - 2) 200 mm (8") apart when installed on slopes greater than 1:1 (12" in 12").

## 4 MATERIALS

NOTE: Click [here](#) to view all the Materials accepted for use in the **RoofStar Guarantee Program**.

### 4.1 General

- 1) All roofing components installed by the *Contractor* must be
  - 1) new
  - 2) accepted by the **RoofStar Guarantee Program**.
  - 3) manufactured by, or listed as acceptable to, the manufacturer of the primary field membrane or water-shedding material.

A list of all *Accepted Materials* is published in this *Manual* (see link above).

Also see **1.6 (2) RoofStar Guarantee: Coverage and Limitations** for restrictions and limitations on any roofing material, *linear metal flashing*, penetration flashing or drain used on a Project qualifying for a **RoofStar Guarantee**.

- 2) All materials must be protected from weather, properly stacked and secured above ground or the roof surface and covered by wrappers approved or recommended by the manufacturer.
- 3) All installed roofing materials that are susceptible to moisture damage must be made watertight by the end of each workday.
- 4) Metals and fasteners must be compatible with each other, to avoid galvanic corrosion which can occur when dissimilar metals come in contact with each other. The size of fasteners shall be determined by the *Design Authority*.
- 5) Notwithstanding the foregoing, asphalt shingles must conform to *CSA A123.5 Asphalt shingles made from glass felt and surfaced with mineral granules*.
- 6) Roofing cement must be asphalt-base conforming to *CGSB 37-GP-5Ma*.
- 7) Lap cement must conform to *CGSB 37-GP 4M*.

#### 4.1.1 Definitions

Refer to the [Glossary](#) for further definitions of key terms used in this **Manual**.

##### **Primary Material**

means a roofing, waterproofing or water-shedding material which is directly exposed to the weather and which is primarily responsible for protecting secondary materials, and the building interior, from water and weather generally. Membranes, metal panels or shingles form the core of this material category.

##### **Secondary Material**

means one which forms part of a *waterproofing system* or *water-shedding system* and which may affect the wind resistance characteristics of the entire assembly but is not necessarily exposed to the weather.



# 5 DECK and WALL OVERLAYS

## 5.1 General

### 5.1.1 Definitions

Refer to the [Glossary](#) for further definitions of key terms used in this *Manual*. See also **2.1.1 Definitions**

### 5.1.2 Design

- 1) When a *supporting deck* structure or *wall* is unsuitable for the application of roofing materials, it must be covered with a RoofStar-accepted overlay. See **2.1 (3)** for *supporting deck* and *wall* surface requirements.
- 2) A *roof deck overlay* is installed as part of the *roof assembly*, on the top surface of the roof deck but beneath the roofing materials. These products are commonly affixed to steel decks to provide a level surface for the roof membrane or air/vapour barrier, or to serve as a thermal barrier between the roof deck and combustible insulation. *Roof deck overlay* materials may also be applied to other types of *supporting deck* structures, depending on the roof design criteria.
- 3) *Wall overlays* are less common on *water-shedding systems* but may be required to provide a suitable surface for self-adhering membrane flashing.
- 4) For *roof assemblies* designed above a vaulted conditioned space, see also **6.1.3.2 Attic Ventilation**.

## 5.2 Materials

- 1) *Deck overlays* and *wall overlays* must be suitable for, and compatible with, any membrane or panel application. Plywood, measuring at least 12.5 mm (1/2") in thickness, is acceptable as a *deck* or *wall* overlay.
- 2) When the Code having jurisdiction requires a thermal barrier, an accepted *deck overlay* must be specified and installed.
- 3) *Walls* that require resurfacing for membrane application must be covered with an accepted *wall overlay*. See [Accepted Wall Overlays](#). See also [Accepted Deck Overlays](#).

## 5.3 Application

### 5.3.1 General

- 1) *Deck overlays* must be
  - 1) of sufficient thickness to allow full penetration of shingle fasteners.
  - 2) installed over any *deck* that is not suitable as a substrate for asphalt shingles (see **Part 2 SUPPORTING STRUCTURES: Decks and Walls**).
  - 3) installed in a staggered pattern (offset) at least 300 mm (12") from adjacent board rows. A minus offset tolerance of 50 mm (2") maximum will be permitted to compensate for variance in the manufacturer's tolerance of differing board widths and lengths.
  - 4) independently fastened to the *supporting deck*.
- 2) *Wall overlays*
  - 1) must be applied to existing sheathing where sheathing is not an acceptable substrate.
  - 2) may be mechanically fastened or adhered.

### 5.3.2 Steel Decks

- 1) Steel decks are not suitable for asphalt shingle application and therefore must be overlaid with a sub-deck that permits ventilation below the sub-deck. See also **2.2.1 Wood Decks** and **2.2.2 Steel Decks**.

### 5.3.3 Wood Decks

- 1) A mechanically fastened overlay is required for any *supporting deck* that does not meet the criteria for a suitable deck surface set out in **2.2.1 Wood Decks**. *Deck overlays* applied to wood *decks* must be securely

fastened with ring-shanked nails having a shank at least 3 mm thick and a head at least 9.5 mm in diameter. Fasteners must penetrate structural material at least 19 mm (3/4").

### 5.3.5 Walls

- 1) Where the *wall* surface is unsuitable to receive a membrane, it must be covered with an accepted overlay material (refer to **Division C: Accepted Materials** in this *Manual*).
  - 2) *Wall overlays* must be
    - 1) mechanically fastened with screw fasteners placed
      - 1) at the perimeters.
      - 2) at the corners.
      - 3) in the field, spaced no less than 300 mm (12") O.C. vertically and horizontally, or in alignment with structural supports of the overlay panels.
    - 2) adhered with a polyurethane adhesive, applied with a continuous z-patterned ribbon spaced no less than 300 mm (12") apart, in alignment with structural supports.
-

# 6 AIR, VAPOUR and VENTILATION CONTROL

NOTE: See more information on [Air and Vapour Control](#) in **Division B: Essential Elements**.

## 6.1 General

### 6.1.1 Intent

Air and vapour control layers, along with thermal barriers, water resistive barriers and water-shedding surfaces, serve to separate the outside environment from the interior environments of a structure. Continuous air control layers are perhaps the most critical. Building Codes in force in each jurisdiction, and the *National Energy Code (2011)*, require the selection and proper installation of “a continuous air barrier system comprised of air-barrier assemblies to control air leakage into and out of the conditioned space” (NEC 2011).

Continuity of the air and vapour control layers from the *wall systems* and *roof systems* is essential to the satisfactory performance of either or both. Therefore, proper connection between air and vapour control *systems* is essential, and the responsibility of both the *Design Authority* and trades constructing *walls* and *roofs*.

**Air control layers** control “flow of air through the building enclosure, either inward or outward” (*Guide for Designing Energy Efficient Building Enclosures, Homeowner Protection Office*). Controlling air flow into and out of conditioned spaces affects the performance of “thermally efficient enclosure assemblies” (ibid), impacts the potential for condensation in between materials, and directly influences rainwater penetration of the building envelope. Some air control layers are considered permeable, others air-impermeable or ‘airtight’. The suitability of one over the other, in the application of a *roof system*, is left to the discernment of the *Design Authority*. **Consequently, the RoofStar Guarantee Program strongly recommends that designers and builders of roof systems intended to qualify for a RoofStar Guarantee carefully consider the regulatory design and installation requirements for effective, continuous air control systems.**

**Vapour control layers** regulate or prohibit the movement of water vapour from one space to another by means of diffusion. Consequently, these control layers are referred to as either vapour-permeable or impermeable. Diffusion is a slow process, in contrast to air movement, and its regulation is not always mandatory or even desirable. Therefore, because continuous vapour control layers “are not needed within all climate zones and assemblies”, they are considered non-critical and may be left to the discretion of the *Design Authority*. **Nevertheless, where continuous vapour control layers are required and specified by Code, the RoofStar Guarantee Program requires that a suitable vapour control system be selected by the Design Authority and properly installed by the Contractor in conformity with the vapour control layer manufacturer’s published instructions, and with the Design Authority’s specified details.**

Any references in this *Manual* to installation methodologies, and any construction details that show air and vapour control layers, are merely illustrative and not prescriptive. **Installers of continuous air and vapour control layer systems are urged to understand and comply with best practices for their application.**

### 6.1.2 Limitations and Exclusions

- 1) Air and vapour control layer performance is not part of the **RoofStar Guarantee**, and air and vapour control materials are not listed in the Accepted Materials Division of this *Manual*. Therefore, the decision to specify air and vapour control layers, the placement of continuous air and vapour control layers in relation to a *roof system* and its components, and the selection of suitable materials for that application, is the sole responsibility of the *Design Authority*. **The Design Authority is urged to review and consider the performance characteristics of materials available for such applications.**
- 2) Neither the **RoofStar Guarantee Program** nor the *Contractor* will accept any responsibility for damage to, or failure of, the *roof system* caused by the use or absence of air or vapour control layers.

- 3) In some *roof assembly* designs, the required underlayment may serve as an air control layer, vapour control layer, or both; this is dependent upon the properties of the material to be used and will be subject to the designer's modelling of the *assembly*. Consult the Technical Data Sheets for suitable materials.

## 6.1.3 Design

### 6.1.3.1 Air and Vapour Control for High-Humidity Building Interiors

- 1) Careful consideration should be given to the performance characteristics of air and vapour control layers when specifying such a membrane for *roof systems* constructed over high-humidity building interiors. These types of building interiors include (but are not limited to)
  - 1) swimming pools
  - 2) commercial laundry facilities
  - 3) large aquariums
  - 4) paper mills

*Roof systems* for facilities such as these, with high-humidity environments, may be susceptible to the accumulation of moisture within the *roof system* unless effective air and vapour controls are installed.

### 6.1.3.2 Attic Ventilation

- 1) The design and selection of the ventilation system is the responsibility of the *Design Authority*, and may be achieved by incorporating into the roof design both intake and exhaust vents, including (without limitation),
  - 1) Eave vents
  - 2) Gable end vents
  - 3) Hip vents
  - 4) Static vents
  - 5) Ridge vents
  - 6) Cupolas
- 2) Attic (roof cavity) ventilation must
  - 1) meet the minimum requirements set out by the Code having jurisdiction, even in conditions where snow cover is present (see *British Columbia Building Code, Part 9 for Housing and Small Buildings, Section 9.19 Roof Spaces, 9.19.1.3 Clearances*). Roofs that do not provide adequate ventilation do not qualify for a **RoofStar Guarantee**.
  - 2) be suitable for the
    - 1) slope of the roof.
    - 2) vented area.
    - 3) design and configuration of the roof structure.
  - 3) be provided for
    - 1) roofs over cathedral ceilings.
    - 2) compact insulated roof assemblies.

See also *Building Ventilation* in **Division B: Essential Elements** of this *Manual*.

- 3) Continuous proprietary ridge venting systems
  - 1) are acceptable and are recommended for all areas with vaulted ceilings.
  - 2) may be installed on slopes 1:3 (4" in 12") and greater, but application on slopes less than 1:3 must be permitted by manufacturer's published installation instructions.

## 6.2 Materials

### 6.2.1 Air and Vapour Controls

- 1) The material selected for air and vapour control layers must be compatible with any other materials in the roof or wall assembly to which the control layer may come in contact. This includes, without limitation, contact with primers and adhesives, substrates, solvents and cleaners.
- 2) Self-adhering or adhesive-applied materials should be considered as alternatives to torch-applied membranes when the substrate to which they will be applied is combustible, or when nearby structures, openings or materials present a fire hazard. In the alternative, a suitable separation or overlay material as protection from open flame is acceptable. The application of materials to a combustible surface, using a torch, is strictly prohibited.
- 3) Fully supported air and vapour control layers should possess a minimum published static puncture resistance rating of 150 N (34 lbf) (ref. CGSB-37.56-M for both test method and standard limits) and be either self-adhering or torch-applied; a high puncture resistance is necessary for the membrane to withstand accidental damage during construction. For unsupported air and vapour control layers, see 6.2 (4) below. Therefore, while responsibility for the selection of suitable air and vapour control layers rests with the Design Authority, a roof designed and built to qualify for a **RoofStar Guarantee** shall not include either polyethylene sheet plastic or bitumen-impregnated kraft paper.
- 4) Notwithstanding any of the foregoing, the **RoofStar Guarantee Program** strongly recommends that any air or vapour control systems be installed over a smooth, continuous plane (for example, concrete or plywood). Consequently, a deck overlay board installed on corrugated steel roof decks is highly recommended. Where no deck overlay board is installed and the air and vapour control layers are partially unsupported (for example, on a steel deck), the control layers each must have a published static puncture resistance of at least 400 N (90 lbf). Furthermore, both the side laps and end laps must be fully supported.
- 5) Should the air or vapour control layers be used as a temporary roof during Project construction by either the Contractor or by other trades, a minimum 2mm thick bituminous membrane is recommended.
- 6) Because curing concrete releases considerable moisture that can compromise the performance of a roof system, a vapour control layer installed on new concrete decks (28 days or older) must be selected to prevent condensation inside the roof system. A membrane with a permeability of 0.01 perms (Class I) is recommended. Nevertheless, the selection of the vapour control material is the responsibility of the Design Authority.

### 6.2.2 Air Vents

- 1) Vents, regardless of their type, must be either
  - 1) proprietary to, or privately labeled for, the shingle manufacturer, or
  - 2) specifically accepted by the **RoofStar Guarantee Program**. See also 11.2.3 Penetration Flashings.
- 2) Ridge vents must be
  - 1) acceptable to the shingle manufacturer.
  - 2) internally reinforced to provide support for shingle caps.
  - 3) suitable for slopes 1:4 and greater.
  - 4) constructed with internal baffles to prohibit the intrusion of
    - 1) insects.
    - 2) vermin.
    - 3) snow.
    - 4) debris.

## 6.3 Application

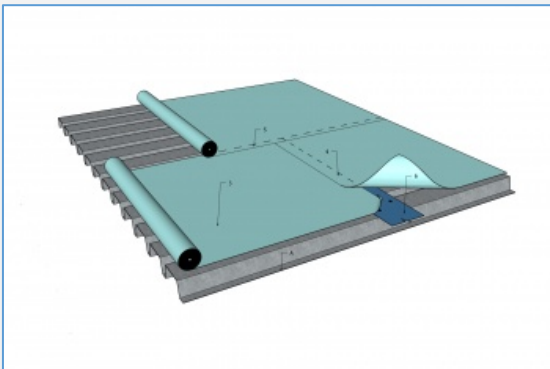
### 6.3.1 Air and Vapour Controls

- 1) Proper installation and continuity of air and vapour control layers within the *roof assembly* is the responsibility of the *Contractor*. Therefore, air and vapour control layers in the *roof assembly* must
  - 1) extend beyond the end of the *roof assembly* at least 100 mm (4"), in new construction, to provide sufficient room for the installation of matching control layers to so that they provide a positive (water-shedding) lap seal union between courses of material.
  - 2) be sealed to matching control layers in the *wall assembly*, for roof replacement *projects*.
- 2) Installation must be smooth and uniform, without wrinkles or fish-mouths, and must also conform to the manufacturer's published requirements and the *Design Authority's* design details.
- 3) All membrane side and end laps must be fully supported, in the field and at transitions with curbs, *parapets*, *walls* and penetrations. When self-adhered membranes are applied directly to a steel *deck*,
  - 1) membranes should be oriented parallel to the direction of the *deck flutes*.
  - 2) membrane laps and changes in plane must be supported by *deck flutes* or flat metal supports secured to the *deck* to span gaps. Metal supports must be
    1. fabricated from pre-finished steel with a thickness no less than 24 Gauge.
    2. secured to the *deck* with no fewer than two (2) compatible screw fasteners per flute.

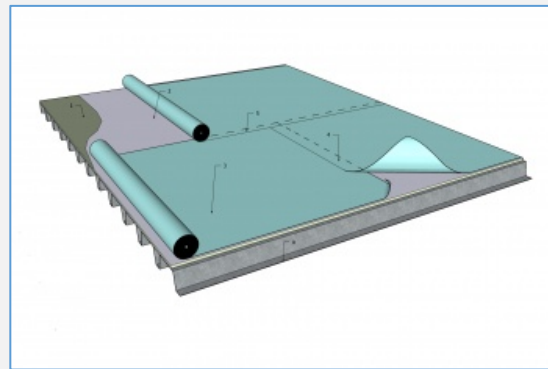
See Figures 6.3.1-1 and 6.3.1-2.

- 4) The application of materials to an unprotected combustible material, using a torch, is strictly prohibited.
- 5) All combustible materials MUST be protected from open flame by an acceptable separation or overlay material. This includes, without limitation, combustible materials
  - 1) on *decks*, *walls*, blocking, and canted edges.
  - 2) hidden or obscured within voids, cracks or orifices.
- 6) When a torch-applied base membrane is specified, all joints between overlay panels, and at roof-wall transitions, must be sealed with the primary membrane manufacturer's approved self-adhered membrane or tapes. Alternatively, refer above to **10.3.3 Alternative Approaches to Membrane Flashing in the RoofStar Guarantee Standards for SBS Modified Bitumen Membrane Systems**.

[Figure 6.3.1-1](#)



[Figure 6.3.1-2](#)



### 6.3.2 Air Vents

- 1) Refer to **11.3.3 Penetrations and Vents** for application requirements.

# 7 INSULATION

## 7.1 General

- 1) Some *water-shedding systems* call for a compact insulated system, as for example when the roof covers a vaulted conditioned space. When this is the case, the following design, material and application requirements, principles and recommendations apply.

### 7.1.1 Definitions

**Heat-resistant insulation** means insulation that resists heat and will not physically or chemically change when exposed to heat greater than 70°C (158°F), including heat from liquefied bitumen. Insulation boards of this type include fibreboard, polyisocyanurate and mineral wool. Note that “heat-resistant” does not mean or even infer ‘fire-proof’. While some heat-resistant insulation materials will resist burning for a period of time, only mineral wool insulation will not burn.

**Heat-sensitive insulation** means insulation that may be physically or chemically altered when exposed to heat greater than 70°C (158°F) - for example, heat from a torch or from liquefied bitumen. *Heat-sensitive insulation* includes EPS, XPS and polyurethane.

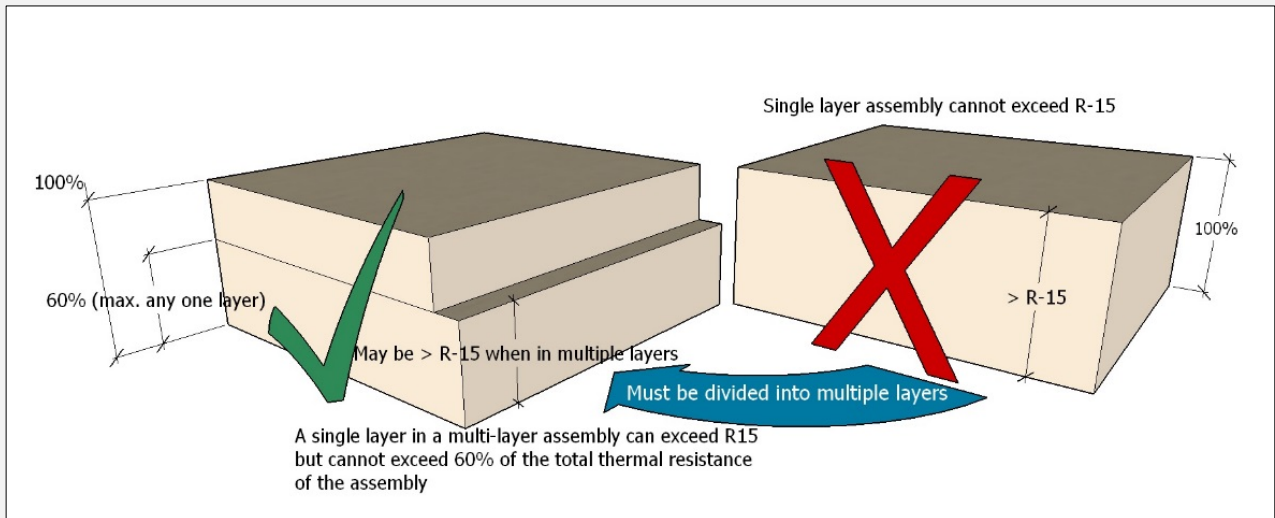
See the [Glossary](#) for other terms used in this Part.

### 7.1.2 Design

- 1) Consult the Code having jurisdiction for the minimum required thermal resistance of the *roof assembly*.
- 2) Insulation compressive strength, when applicable, must be taken into consideration by the structural engineer.
- 3) Insulation materials rely on various standards for the determination of thermal resistance, which means that not all data can be easily compared. Furthermore, not all insulation products perform with consistent thermal resistance as temperature changes, and some insulation performance declines with age. The *Design Authority* is therefore urged to consider the Long-term Thermal Resistance (LTTR) for each product, in relation to its placement within the *roof system* and the anticipated outside and interior climates of the building.
- 4) In warm seasons, the roof surface may reach temperatures higher than 85°C (185°F), affecting the performance and stability of some insulation. Combining insulation types in a *roof system* may help mitigate these temperature swings and consequential distortion of the *system*. The *Design Authority* therefore must consider these variables when specifying materials and their installation.
- 5) **Only heat-resistant insulation is recommended for use in an insulated, ventilated roof assembly covered with asphalt shingles.** When *heat-sensitive insulation* is desirable, the *Design Authority* should calculate the anticipated maximum temperature for the upper surface of the insulation assembly and ensure the insulation material’s service temperature is suitable for the design.
- 6) Insulation *assemblies* with a cumulative thermal resistance greater than RSI-2.64 (R-15) (based on published LTTR values measured at 24°C) must be installed in multiple layers that are offset and staggered (see **7.3 Application**). Within that multi-layered assembly, any single layer of insulation may have a thermal resistance greater than RSI-2.64 (R-15) provided no one layer exceeds 60% of the cumulative thermal resistance of the combined *assembly* of insulation and insulation overlay boards.

See **Figure 7.1**.

Figure 7.1



## 7.2 Materials

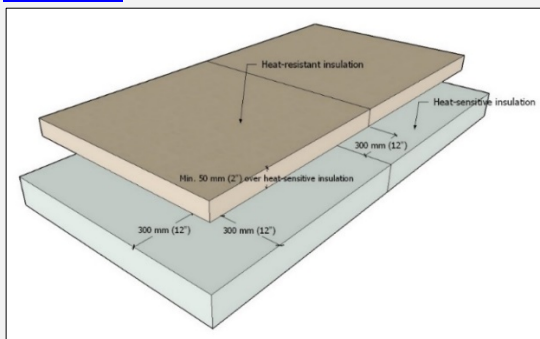
- 1) The type of insulation is to be specified by the *Design Authority*. A list of acceptable insulation materials may be found in [Roof Deck Insulation](#).
- 2) Material dimensions:
  - 1) The maximum width and length of any adhered insulation panel shall be 1200 mm (4')
  - 2) The maximum width and length of insulation boards installed with mechanical fasteners is limited only by the manufacturer.
  - 3) Insulation installed directly over a fluted steel deck must be thick enough to span the flutes under live loads (minimum live load equal to or greater than 115 Kg (253 lbs); see also **9.1.1 Design**), without risk of cracking or breakage.
  - 4) **While minimal insulation panel thicknesses are permissible for some designs, the *Design Authority* should consider the constructability of the roof system from a material handling perspective. Therefore, when materials are by their nature breakable, the specifier should consider specifying a thicker panel.**

## 7.3 Application

### 7.3.1 Layering

- 1) See **7.1.2 (6)** above.
- 2) Insulation board joints must be offset at least 300 mm (12"), both for adjacent layers and for adjacent rows; a minus offset tolerance of 50 mm (2") maximum is permissible (see **Figure 7.2**).

Figure 7.2





### 7.3.2 Alignment, Sizing and Support

- 1) Insulation boards must be
  - 1) firmly supported.
  - 2) square and make firm, full contact with adjacent panels. Gaps greater than 10 mm (3/8") between boards must be filled with expanding spray foam or chinked with fibreglass wool.
  - 3) offset at least 300 mm (12"), both for adjacent layers and for adjacent rows.

### 7.3.3 Securement

Refer to **Part 3 SECURING the ROOF ASSEMBLY**.

---

# 8 EAVE PROTECTION and UNDERLAYMENT

## 8.1 General

### 8.1.1 Definitions

#### ***Eave and Valley Protection***

means a self-adhering membrane applied in valleys and in parallel courses on the roof *deck* along the eaves, up the roof slope to a point measured vertically from the inside of the exterior *wall*, and intended to block the ingress of water that may leak behind shingles or metal roof panels as the result of snow or ice buildup on the roof surface.

#### ***Underlayment***

(sometimes referred to as Waterproof Shingle Underlayment (WSU)) means a roll material that is either self-adhering or mechanically fastened (typically with large head nails), and which is installed

- 1) immediately over the *supporting deck*.
- 2) to provide secondary protection between the *water-shedding system* materials and the building interior.
- 3) to keep *water-shedding system* materials from adhering to the *deck*.

See the [Glossary](#) for other terms used in this Part.

### 8.1.2 Design

- 1) Eave protection is required on all *Common Slope*, *Steep Slope* and *Extreme Slope* roofs, but is not required
  - 1) over unheated spaces.
  - 2) where the roof overhang exceeds 915 mm (3') measured along the roof slope from the edge of the roof to the inner face of the exterior wall.
- 2) An underlayment is required
  - 1) beneath all *water-shedding system* materials, irrespective of slope.
  - 2) on vertical surfaces where roofing materials and flashings adjoin walls or curbs.
  - 3) beneath all penetration flashings.
- 3) When the roof slope is less than 1:3, the underlayment over the entire roof – in the field, on vertical surfaces and beneath all penetrations – must be self-adhering. See **8.2.1 Eave Protection and Underlayments** for material requirements.
- 4) **In all applications, a non-adhering roof field underlayment may be specified as a separation layer over any self-adhering membrane (used as eave and rake protection, or as a full underlayment on Low Slope or Flat roofs), to separate the shingles from the membrane and thus prohibit bonding of the two. This approach may simplify future shingle replacement, as a result, spare the supporting deck from damage during tear-off.**
- 5) *Linear metal flashings* along the eave and rake (gable) edges are required on all *projects* and must be separated from direct contact with wood surfaces. See also **Part 10 PERIMETERS and WALLS**, and **Part 13 METAL FLASHINGS**.

## 8.2 Materials

Accepted materials for this purpose are listed in the [Eave Protection & Underlayment \(Architectural Metal Roofing\)](#) table of this *Manual*.

- 1) Materials used for *eave or valley protection*, or as an underlayment, must be selected from the list of Accepted Materials.
- 2) When a material not listed in the Accepted Materials is specified for application in an Asphalt Shingle Roof System, the *Design Authority* must request a written Variance from the **Guarantor**.
- 3) All membranes must provide proprietary sealants, mastics, tapes and/or primers suitable for the application of the *underlayment* and must be applied in accordance with the manufacturer's written instructions.

## 8.2.1 Eave Protection

For materials acceptable under the **RoofStar Guarantee Program**, see [Eave Protection & Underlayment](#).

- 1) Membranes used for *eave and valley protection* must be
  - 1) self-adhering.
  - 2) have a sanded or synthetic, non-bonding top surface.
  - 3) at least 1.4 mm thick or, in the alternative, another RGC-accepted *eave protection* membrane supported in writing by the asphalt shingle manufacturer. Written confirmation from the manufacturer must be submitted to the **Guarantor** as part of the project documentation.

## 8.2.2 Underlayment

- 1) Underlayments may include any of the following:
  - 1) At least one ply of 15 lb. non-perforated asphalt saturated felt conforming to *CSA A123.3 M1979* and/or *ASTM D226-95*, and as acceptable under the **RoofStar Guarantee Program** (see [Eave Protection & Underlayment](#) for asphalt shingle roofing).
  - 2) RoofStar-accepted synthetic underlayment.
  - 3) RoofStar-accepted self-adhering membranes with a minimum thickness as described in **8.2.1(1)(3)** above, for roof slopes less than 1:3 (4" in 12"). Alternatively, multiple layers of a thinner membrane may be used, but must be installed with offset vertical and horizontal seams.
- 2) **Because synthetic and fully adhered membranes vary in vapour permeability, consult the manufacturer's specifications and ventilation requirements of the Code.**

## 8.2.3 Fasteners

- 1) While mechanical fasteners used to secure underlayments must conform to the underlayment manufacturer's requirements, the use of staples is not permitted.

## 8.2.4 [NOT USED]

## 8.2.5 [NOT USED]

## 8.2.6 Linear Metal Flashings

- 1) See **Part 13 METAL FLASHINGS**

# 8.3 Application

## 8.3.1 Eave Protection

### 8.3.1.1 General

- 1) *Eave protection* is required on all *Common Slope*, *Steep Slope* and *Extreme Slope* roofs, but is not required
  - 1) over unheated spaces.
  - 2) where the roof overhang exceeds 915 mm (3') measured along the roof slope from the edge of the roof to the inner face of the exterior *wall*.
- 2) Self-adhering *eave protection* is required irrespective of roof slope, and must
  - 1) overhang the fascia by at least 25 mm (1").
  - 2) extend up the slope at least 915 mm (3'), or to a line not less than 300 mm (12") inside the inner face of the exterior wall (**600 mm (24") in regions with heavy snow**).
  - 3) extend up all abutments (walls, skylights, etc.) at least 150 mm (6") above the surface of the *finished water-shedding system*.
- 3) Horizontal runs of *eave protection* must be positively lapped at least 50 mm (2") and end laps (vertical joints) must be at least 150 mm (6").

## 8.3.2 Underlayment

### 8.3.2.1 General

- 1) An *underlayment* must be installed
  - 1) 'shingle fashion' and fastened
    - 1) according to the manufacturer's published instructions, using acceptable fasteners.
    - 2) with roofing nails (in the absence of other instructions).
  - 2) parallel to the eave, and each course of *underlayment* must positively overlap adjacent material by
    - 1) at least 75 mm (3") along the sides, unless exceeded by the manufacturer's instructions.
    - 2) at least 150 mm (6") at the ends, unless exceeded by the manufacturer's instructions.
  - 3) beneath all *water-shedding system* materials, irrespective of slope.
  - 4) beneath all perimeter *linear metal flashings*.
  - 5) beneath all penetration flashings.
  - 6) on vertical surfaces where roofing materials and flashings adjoin walls or curbs, at least 150 mm (6") above the *roof deck*.
- 2) When the roof slope is less than 1:3, the underlayment over the entire roof – in the field, on vertical surfaces and beneath all penetrations – must be self-adhering. See **8.2.1 Eave Protection and Underlayments** for material requirements.
- 3) Where negative (backward) laps are unavoidable, only a RoofStar-accepted self-adhering underlayment may be used. Negative laps must be at least 150 mm (6"), and seams must be roller-pressed and sealed with a compatible mastic along the seam edge.
- 4) Organic felt underlays and asphalt shingles must be applied on the same day. **To prevent wrinkling, let felt relax before installing.**
- 5) **To prevent shingles from bonding to self-adhering membranes, and simplify future roof replacement, a non-bonding underlayment may be used as a separation layer between the shingles and the membrane.**

### 8.3.2.2 Low Slope Roofs

- 1) In addition to the General requirements above, *Low Slope* roofs may be fully covered with
    - 1) one layer of self-adhering *eave protection* membrane equal to or exceeding the minimum thickness requirements, or
    - 2) multiple layers equal to or exceeding 1.4 mm in thickness; the second layer must be offset from the first by at least 300 mm (12"), both horizontally and vertically.
-

# 9 FIELD SHINGLES

## 9.1 General

- 1) The Standards published in this Part, and in those that follow, reflect the level of attention to design and application required by the designed slope of the roof. Shingles are *water-shedding* materials, and low slopes may affect the flow of water, necessitating more rigorous requirements to keep water from reaching the *supporting deck* and the conditioned space of the building.

## 9.2 Materials

- 1) All asphalt shingles shall be manufactured in compliance with the material standards found in CSA A123.5 *Asphalt shingle application on roof slopes 1:6 and steeper*, and shall in any event
  - 1) be reinforced with fibreglass or an accepted composite reinforcement scrim and shall not be manufactured with organic materials.
  - 2) clearly mark the fastening zone or line, which must be centered on the common bond area.
  - 3) provide discontinuous adhesive strips on the bottom face of the shingle's exposure, manufactured from SEBS or an accepted material deemed equivalent or better by the **RoofStar Guarantee Program**, and free of any trails that would trap or impede the flow of water beneath the shingle.
- 2) *Starter* shingles or rolls must be acceptable to the field shingle manufacturer.

### 9.2.1 Shingles for Low Slope Roofs

- 1) Shingles must be
  - 1) expressly manufactured and accepted for application on *Low Slope* roofs.
  - 2) manufactured to CSA A123.5 *Asphalt shingle application on roof slopes 1:6 and steeper* for fibreglass felt shingles with a minimum mass of 10.50 kg per m<sup>2</sup> (215 lb per 100 sf).

## 9.3 Application

### 9.3.1 General

- 1) See **Part 3 SECURING the ROOF ASSEMBLY** for field shingle nailing requirements.
- 2) Asphalt shingles shall be installed to CSA-A123.51 *Asphalt shingle application on roof slopes 1:6 and steeper*.
- 3) Shingles shall be kept inside the manufacturer's packaging until the time of application and must be free of damage or contamination on the sealing strips.
- 4) A *starter course* or strip-type shingle is required at the eaves and rake (gable) edges, below the first course of shingles and must be installed
  - 1) flush with the edges of the underlayment.
  - 2) onto the valley metal and membrane flashings.
  - 3) with no fewer than four (4) nails (see fastening requirements in **3.3 Application**).
- 5) Each course of shingles following the first course shall be installed so that
  - 1) all vertical and horizontal lines running true, or follow a random pattern as directed by the manufacturer's printed instructions.
  - 2) shingles extend beyond (whichever is greater)
    - 1) the eaves or a fascia board approximately 37 mm (1 ½"), to lead water into eaves troughs.
    - 2) The rake (gable) flashings by approximately 12 mm (1/2").
  - 3) exposure and nailing patterns conform to the manufacturer's printed product-specific instructions.
- 6) Each succeeding course of shingles must offset according to the shingle manufacturer's published instructions, but in any even shall not be less than 125 mm (5"). Notwithstanding this requirement,
  - 1) shingle segments used to cover rafter tails shall not be bound by minimum width requirements but must be centred on the rafter tail and overlap its edges by at least 12 mm (1/2").

- 2) shingle segments used around penetration flashings and vents, or adjacent to valleys, must not be less than 200 mm (8") in width.
- 7) So-called "Dutch laps" are not permitted.
- 8) When shingles are installed in cooler temperatures (typically below 10° C), shingles must be
  - 1) hand-sealed with a shingle cement/adhesive acceptable to the shingle manufacturer.
  - 2) fastened with additional nails, as specified by the manufacturer.
- 9) When roofing work is complete, the *Contractor* must remove all temporary fall protection fittings and equipment.
- 10) If permanent fall protection anchor points are desirable, they must be specifically required and allocated by the *Design Authority* and incorporated into the roof design.

### 9.3.2 Low Slope Roofs

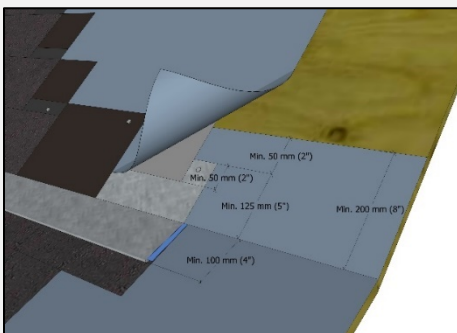
- 1) Shingles may not be installed on *Low Slope* roofs unless expressly permitted by the shingle manufacturer.
- 2) Shingles on *Low Slope* roofs must be installed over a self-adhering membrane or multi-layered membrane. See **8.3.2.2 Low Slope Roofs** for application requirements.

### 9.3.3 Changes in Slope

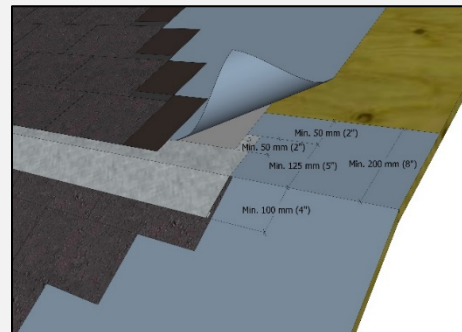
- 1) When the field roof slope changes more than 1:6 (2" in 12"), the transition in slope must be made to the following standards:
  - 1) *Underlayment* for the lower roof area must be brought up onto the upper roof *deck* at least 200 mm (8") but must extend past the top edge of the metal transition flashing by at least 50 mm (2").
  - 2) The lower roof shingles must be terminated at the slope transition line.
  - 3) A metal transition flashing is required and must be
    - 1) broken (bent) to
      - 1) bridge the transition.
      - 2) exert pressure on the lower slope shingles.
    - 2) installed over the *underlayment*.
    - 3) secured to the upper slope with mechanical fasteners set in from the edge of the flashing 25 mm (1") and spaced no more than 300 mm (12") O.C.
    - 4) lapped over the shingles on the lower slope at least 100 mm (4"); **a hidden cleat used to secure the lower edge of the metal flashing is recommended but not required.**
- 4) When the angle between slopes is less than 180° (when the lower roof plane slope is less than the slope of the upper roof plane), a self-adhering membrane strip is required to overlap the upper edge of the metal flashing by at least 50 mm (2"); the membrane must extend up-slope at least 50 mm (2") past the bottom layer of *underlayment* and be sealed to the roof *deck*.
- 5) Shingles installed on the upper slope must be started and installed as a new slope, in keeping with the requirements in this Standard.

See **Figure 9.1** and **Figure 9.2**.

**Figure 9.1**



**Figure 9.2**



# 10 PERIMETERS and WALLS

## 10.1 General

### 10.1.1 Definitions

#### **Valley**

means the concave angle formed by the intersection of sloping roof planes.

See the [Glossary](#) for other terms used in this *Manual*.

### 10.1.2 Design

- 1) *Linear metal flashings* described in any Part of this Standard are considered necessary and integral to the scope of a *project* designed and constructed to qualify for a **RoofStar Guarantee**. Furthermore, only new linear metal flashings may be specified and installed; reuse of any existing *linear metal flashings* is prohibited and may void the *Guarantee*. See also **1.6 RoofStar Guarantee: Coverage and Limitations**.
- 2) The *Design Authority* is responsible to specify continuity so that intersecting *systems* are positively connected. See **10.3.2 Sequencing**.
- 3) *Linear metal flashings* must be
  - 1) installed along all eave and rake (gable) edges, and
    - 1) extend at least 50 mm (2") onto the roof *deck*.
    - 2) be securely fastened to the deck with acceptable nails placed no more than 400 mm (16") O.C.
  - 2) separated from a wood substrate with self-adhered *eave protection* membrane or mechanically fastened *underlayment*.
- 4) Fascia may be covered with metal flashing and specified as part of the *roof system*.
- 5) The weathering surface of shingles must be protected from damage during the life of the roof, including damage by funneled water. Therefore, the roof design must incorporate methods for managing the flow of water from one roof surface to another.
- 6) Where a *Steep Slope* roof plane drains onto a *Common Slope* or *Low Slope* roof, the valley metal flashing must be fashioned with double inverted "V" dividers. Refer to **Figure 13.3** for valley flashing requirements.
- 7) Diverter flashings
  - 1) must be used at the bottom end of a wall that intersects a roof parallel to the slope. See **10.3.1 General (Application)** for specific requirements.
  - 2) **are not mandatory at rake edges (gable ends) but are recommended to direct water away from barge rafters and exposed fascia tails, and to direct water into gutters.**
- 8) Metal valleys must be used for laminate, interlocking and *Low Slope* shingle applications, and in any event are recommended for all roof designs.
- 9) Step flashings must be used to flash roof transitions with walls, parapets or curbs ranging from 90° to 120°, when measured on the face of the slope from the eave edge.
- 10) A back-pan flashing must be used when a wall, parapet or curb intersects the roof plane at 120° or more, measured on the face of the slope from the eave edge.
- 11) A head-wall flashing must be used only at the top of a sloped roof, where a *wall, parapet* or *curb* intersects the roof perpendicular to the slope or at an angle to the slope not exceeding 45° down. The flashing must be inserted behind the wall finish and extending over the top course of shingles at least 100 mm (4"). See also **10.3.5.1 Eave, Rake (Gables) and Wall Flashings**.
- 12) An apron flashing must be used at the bottom of a *curb* or chimney.
- 13) When a *wall* at the top of a slope changes plane at the corner, the corner must be flashed with a headwall flashing fashioned to turn up the slope.

- 14) **Dead valleys should be avoided**, but when a roof slope terminates in a dead valley, the design must conform to the Application standards in **10.3.5.2.5**.
- 15) Ridge vents may be used only on horizontal ridges. For ventilation of hip roofs, refer to **6.1.3.2 Attic Ventilation**.

## 10.2 Materials

### 10.2.1 General

- 1) *Starter* shingles or rolls must be acceptable to the field shingle manufacturer.
- 2) Caps used on hips and ridges must be acceptable to the field asphalt shingle manufacturer and be of the same material as the shingles.
- 3) Membranes used to flash transitions with walls, parapets or curbs must meet the Standards found in **8.2.1 Eave Protection and Underlayment**.
- 4) Membranes used in built-in gutters or dead valleys must meet the requirements found in **12.2.2 Materials**.

### 10.2.3 Fasteners

- 1) All fasteners must be compatible with the materials they will contact, including all metal flashings.
- 2) Cladding Screws: Minimum No. 8 (3/8") gauge with rubber gasket grommet or washer made of metal compatible and corresponding in colour to metal flashing material.
- 3) Ridge cap fasteners must be at least 44 mm (1 3/4") long but must nevertheless be long enough to penetrate the roof deck by at least 19 mm (3/4").

### 10.2.4 Sealants

- 1) See **13.2.4 Sealants**.

## 10.3 Application

### 10.3.1 General

- 1) The standards in this Part may not include every possible detail the *Contractor* will encounter, but every installation must be executed in keeping with the following:
  - 1) Every transition in plane must be flashed (under-laid) with a non-adhering underlayment or a self-adhering membrane; the choice is slope-dependent and at the discretion of the *Design Authority*, but in any event is subject to the standards in **Part 8 EAVE PROTECTION and UNDERLAYMENT**.
  - 2) The underlayment below shingles, regardless of its type, serves as the final water barrier above the *roof deck*.
  - 3) All materials must be installed in overlapping layers that positively shed water to a lower surface; asphalt shingles must be installed to provide double coverage.
  - 4) Materials must be secured in accordance with various Parts in this Standard.
  - 5) Water must be allowed to flow freely off the roof.
  - 6) Nails must never be exposed to water.
- 2) See **Part 3 SECURING the ROOF ASSEMBLY** for shingle nailing requirements.
- 3) *Linear metal flashings* must be
  - 1) installed along all eave and rake (gable) edges, and
    - 1) extend at least 50 mm (2") onto the *roof deck*.
    - 2) be securely fastened to the deck with acceptable nails placed no more than 400 mm (16") O.C.
  - 2) installed at every intersection with a wall.
  - 3) separated from all substrates with self-adhered *eave protection* membrane or mechanically fastened *underlayment*.
- 4) A *starter course* is



- 1) required at all eaves.
- 2) **recommended at rake (gable) edges.**
- 5) **In valleys and at eave and rake edges, extend the *underlayment* over the self-adhering membrane to keep shingles from bonding to the membrane.**
- 6) When rafter tails or barge rafters extend past the eave edge and are flush with the *roof deck*, they should be protected
  - 1) with shingles.
  - 2) a metal cap flashing that is
    - 1) fabricated with drip edges along all three sides and a flange extending onto the *roof deck*.
    - 2) secured with at least two (2) fasteners.
- 7) Fascia flashings, when specified, must be fastened on the vertical face no more than 600 mm (24") O.C. in a staggered pattern; fasteners must be placed at least 25 mm (1") from top edge of the fascia.

### 10.3.2 Sequencing

- 1) *Projects* must follow proper sequencing. This means that materials must be installed so that they interface with other materials, systems or assemblies, including those installed by other trades, in "shingle fashion" by positively overlapping them below or above. Occasionally, the coordination with other trades requires some adaptation to this requirement. When that is the case, any variance to proper detail sequencing must be approved by the *Design Authority* in writing.

### 10.3.3 [NOT USED]

### 10.3.4 [NOT USED]

### 10.3.5 Perimeters and Walls

#### 10.3.5.1 Eave, Rake (Gable) and Wall Flashings

- 1) See **13.3.1 Fabrication** for metal flashing requirements. See also **13.3.2 Securement and Seams** for seaming requirements.
- 2) Eaves must be constructed to the following Standards:
  - 1) *Linear metal flashings* at the eaves and rakes (gable edges) are required on all *Projects*.
  - 2) *Eave protection* or metal flashing *underlayment* must overhang eave fascia at least 25 mm (1"), to direct water into gutters. See also **8.3.1 Eave Protection**.
  - 3) Eave metal flashing must be installed
    - 1) above a separation layer.
    - 2) below the *eave protection* layer.
    - 3) so that the flashing extends at least 12 mm (1/2") past the edge of the *supporting deck*, to accommodate gutter hangers (for existing or specified gutters).
    - 4) with nails driven through the flashing leg into the *roof deck* no more than 400 mm (16") O.C.
  - 4) All types of shingles installed on *Common Slope* and *Steep Slope* roofs must
    - 1) be installed with a *starter course* along the eaves.
    - 2) overhang the fascia approximately 37 mm (1 1/2"), **or with sufficient overhang to lead water into exposed eaves trough. Extend the overhang further for Low Slope roofs.**
- 3) Rake (gable) edges must be constructed to the following standards:
  - 1) continuous *linear metal flashings* must be installed
    - 1) above a separation layer.
    - 2) with nails driven through the flashing leg into the *roof deck* no more than 400 mm (16") O.C.
  - 2) Asphalt shingles must be installed so that they overlap a rake (gable) edge by at least 12 mm (1/2"), unless exceeded by the manufacturer's published requirements.
  - 3) Shingles installed on *Low Slopes* must be sealed in a bed of compatible mastic at all rake edges.

- 4) Step flashings connecting the roof to a *wall* must be constructed to the following standards:
  - 1) Only new step flashings are permitted (cloning is not allowed), and step flashings shall
    - 1) extend at least
      - 1) 125 mm (5") up vertical surfaces behind *wall* control layers (e.g. water, vapour, air) or a counterflashing (where used).
      - 2) 100 mm (4") horizontally between courses of roofing.
    - 2) have a 75 mm (3") head-lap above the shingle exposure.
    - 3) be placed flush with the butt edge (bottom) of each asphalt shingle course.
    - 4) fastened with nails located 50 mm (2") down from the top edge and 25 mm (1") in from the outside edge on the *deck* flange portion of each step flashing.
  - 2) Where step flashings are used, a drainage path of no less than 6 mm (1/4") and no more than 12 mm (1/2") must be provided between the edge of the shingle and the vertical face of the step flashing.
  - 3) When the fascia board extends above the surface of the *finished water-shedding system*, step flashings trimmed to the height of the fascia must be used. Cap flashings that cover the top surface of the fascia board must be joined and secured in keeping with the standards in **13.3.2 Securement and Seams**.
- 5) Head wall and Apron flashings must be
  - 1) installed behind wall control layers (e.g. water, vapour, air) or a counterflashing (where used).
  - 2) extend at least 100 mm (4") over roofing material.
  - 3) secured
    - 1) to the wall with nails set no closer than 300 mm (12") O. C. (new construction).
    - 2) through the shingles into the supporting roof deck with cladding screws
      - 1) spaced every 600 mm (2').
      - 2) located at least 25 mm (1") in from the safety edge of the flashing. Lengths of flashing may be overlapped rather than seamed; ensure that each overlap measures at least 100 mm (4") when fully caulked in the lap, or 150 mm (6") when installed without caulking in the lap.
  - 4) combined with an inside corner step flashing where a shingled slope intersects with an overhanging soffit.
- 6) A diverter flashing, to direct water into gutters,
  - 1) must be installed under the first course of shingles at the junction of roof eaves and a *wall* and must be installed over roof material by at least 100 mm (4").
  - 2) may be installed at the lower end of a rake edge under the second course of shingles.

### 10.3.5.2 Valleys

#### 10.3.5.2.1 Valley Protection Membrane

- 1) Valleys must be protected with membrane that must be
  - 1) installed in all types of roof valleys.
  - 2) an Accepted material (see **8.2.1 Eave Protection and Underlayments**).
  - 3) at least 900 mm (36") in width, or wide enough to extend past the outside edges of a metal valley flashing onto each roof field by at least 150 mm (6").
  - 4) centred along the valley.
  - 5) installed lengthwise along the valley, from the eave edge to at least 50 mm (2") past the upper end of the metal valley flashing.
  - 6) positively overlap
    - 1) lower runs of valley membrane by no less than 150 mm (6"), rolled to ensure even, full adhesion.
    - 2) membrane installed at the eaves.

### 10.3.5.2.2 Open Valleys

- 1) Open valleys are the only style permitted for
  - 1) lock-type shingles.
  - 2) laminated asphalt shingles.
  - 3) *Low Slope* roofs.
- 2) Open valleys
  - 1) for any slope may be constructed with a sheet metal valley flashing.
  - 2) for *Common Slope* and *Steep Slope* roofs may be constructed with one layer of granule-faced SBS-modified bituminous membrane
    - 1) measuring at least 3.7 mm thick and 1 m (39") wide.
    - 2) centred in the valley and fastened with nails spaced not more than 450 mm (18") located 25 mm (1") away from the membrane edges.
- 3) Metal valley flashings must
  - 1) be installed before any shingle application. The installation of shingle *starter* strips beneath the metal valley flashings is not acceptable.
  - 2) be installed without joints or fasteners where eave protection membrane is installed, but where shorter lengths are unavoidable a membrane connection must be made between the two lengths of valley flashing.
  - 3) be secured to the *deck*
    - 1) with fasteners nailed through the metal flashing
      - 1) no more than 450 mm (18") O.C.
      - 2) approximately 25 mm (1") in from the edge of the metal flashing.
    - 2) with cleats nailed to the *roof deck* no more than 450 mm (18") O.C. and hooked onto the outside edges of the flashing.
  - 4) extend to
    - 1) the edge of the eaves.
    - 2) the upper end of the valley or, where a slope continues above it, beyond the valley to a point no less than 300 mm (12") past the termination of the valley.
  - 5) positively overlap adjoining lengths of flashing (shingle-style), where each overlap measures at least
    - 1) 200 mm (8") when fully caulked in the lap.
    - 2) 300 mm (12") when installed without caulking in the lap.
  - 6) have a single central upstanding diverter/divider, except where the valley is less than 1200 mm (48") long.
  - 7) have two evenly spaced upstand diverters/dividers where a *Steep Slope* roof drains onto a *Common Slope* or *Low Slope* roof. See **13.3.1 Fabrication** for metal flashing requirements.
  - 8) be sealed to the valley protection membrane with a strip of the same membrane material, when installed on low-slope roofs or in regions with high snow accumulation; each strip must measure at least 150 mm (6") in width, and must be centred along each edge of the flashing.
- 4) All shingles terminating at the valley must be
  - 1) cut so that space between the cut edges of opposite roof faces widens toward the eave.
  - 2) trimmed diagonally at upper corners on the head lap.
  - 3) secured no closer than 150 mm (6") from the valley centreline.
  - 4) no less than 200 mm (8") in width (see **9.3.1 General**).
  - 5) sealed in a bed of compatible mastic (*Low Slope* applications only).
- 5) So-called California-type valleys are permissible for laminated shingles, subject to approval by the shingle manufacturer, and must be constructed in keeping with the following Standards or the manufacturer's published installation requirements, whichever are greater:
  - 1) Laminated shingles used as a valley *starter* must be

- 1) laid end to end vertically up each side of the installed metal valley flashing, so that their bottom edges align with and are set back from the centre of the valley by at least 50 mm (2"); use a chalk lines for guidance.
  - 2) nailed along the shingle manufacturer's designated fastening zone or line using at least four (4) fasteners per shingle (see **Part 3** for securement requirements).
- 2) Laminated field shingles (uncut) must be
- 1) laid perpendicular to the roof slope and overlap the valley *starter* shingles installed on either side of the valley centreline.
  - 2) secured no closer than 150 mm (6") from the butt edge of valley *starter* shingles.
  - 3) completely cover the butt-end joints of valley *starter* shingles.
  - 4) no less than 200 mm (8") in width (see **9.3.1 General**).
  - 5) installed in keeping with the requirements in **Part 9**.

#### 10.3.5.2.3 Woven Valleys

- 1) Woven valleys must be constructed only with single-layer three-tab shingles and are not acceptable for laminated shingles.
- 2) Valley shingles must be woven together as follows:
  - 1) The first course on one roof area must be laid along the eaves so that it extends across the valley, onto the adjoining roof area at least 300 mm (12").
  - 2) The first course on the adjacent roof area must be laid so that it also extends across the valley, onto the adjoining roof area and on top of the previously applied shingles.
  - 3) Continue this method, alternating from one side of the valley to the other, weaving the shingles together as subsequent courses are installed.
  - 4) Shingles must be secured
    - 1) no closer than 150 mm (6") from the valley centreline.
    - 2) both at the end of the manufacturer's designated fastening zone or line, and with an extra nail at the upper corner of the shingle.

#### 10.3.5.2.4 Closed-Cut Valleys

- 1) Closed-cut valley may be used only on roof slopes exceeding 1:3 (4" in 12"), and only if permitted in writing by the shingle manufacturer. Closed-cut valleys may **not** be used with laminated asphalt shingles.
- 2) Shingles must be pressed tightly into the valley.
- 3) No nails may be fastened within 150 mm (6") of the valley centreline.
- 4) Two nails must be used to secure the ends of the shingles in the valley; fasten the overlapping shingles both at the end of the manufacturer's designated fastening zone or line, and with an extra nail at the upper corner of the shingle.

#### 10.3.5.2.5 Dead Valleys and Valley Transitions

- 1) Dead valleys must be
  - 1) waterproofed following the standards for membrane gutters (see **12.2 Built-in Membrane Gutters**).
  - 2) positively drained with a minimum slope of 1:50 (2%, or 1/4" in 12")
    - 1) into one or more roof drains, or
    - 2) onto a lower *water-shedding* roof. Transitions from *waterproofing systems* to *water-shedding systems* must be made in keeping with the Standards for roof *Waterproofing Systems*. A metal flashing incorporated with the membrane and extending at least 100 mm (4") past a juncture with a wall, to divert water away from the wall, is required. See also **10.3.5.5 Junctions with Waterproofing Systems**.
- 2) Where a ridge and valleys of one roof intersects another shingled roof plane,

- 1) the valley protection membrane and metal valley flashing must be carried up the adjoining slope at least 300 mm (12").
- 2) two self-adhering membrane patches are required:
  - 1) **Lower patch:** cover the peaked joint between valley metal flashings and extend the patch up the slope at least 150 mm (6"); the width of the patch must not exceed the exposure of the ridge cap shingles.
  - 2) **Upper patch:** overlap the lower patch by at least 50 mm (2") and extend up the slope at least 150 mm (6") past the metal.
- 3) ridge cap shingles and the continuing courses of shingles on the main roof slope must be installed using a Split Ridge Cap Shingle Transition (see Construction Detail [ASh 10.5.1 Valley Transition \(Upper\)](#)).
- 3) When a metal valley changes slope, direction or both,
  - 1) self-adhering valley membrane protection must be continuous across the slope transition.
  - 2) each valley must be flashed with a separate metal valley flashing.
  - 3) a flexible membrane flap (i.e. 1.524 mm (60 mil) EPDM) or accepted mouldable material must be used to bridge the slope transition; the membrane must be adhered to the lower valley metal flashing and loosely tucked beneath the upper flashing, extending at least 100 mm (4") on either side of the slope transition.
  - 4) metal valley flashings must positively overlap, ideally no less than 200 mm (8"); where the minimum overlap is not achievable, use a larger flexible membrane flap to achieve an overall overlap of 200 mm (8").

#### 10.3.5.3 Ridge and Hip Caps

- 1) Ridge and hip caps must be
  - 1) installed according to the manufacturer's published instructions, or to these Standards, whichever are greater.
  - 2) applied to provide a minimum double coverage, including the first cap.
  - 3) secured in keeping with **Part 3**; nails must penetrate through, or at least 19 mm (3/4") into, the roof deck.
  - 4) free of exposed nails, except for the last cap; use an acceptable sealant to seal exposed nails (see **10.2.4 Sealants**).

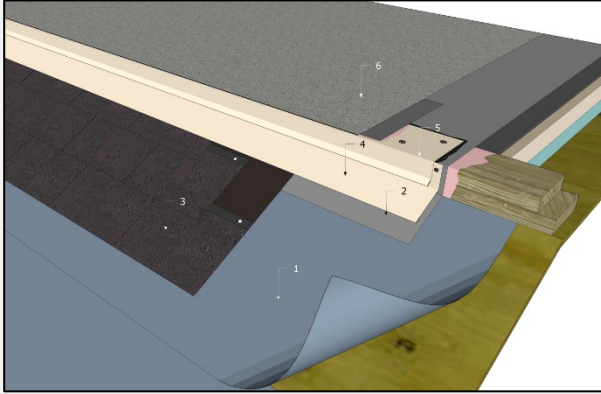
#### 10.3.5.4 Junctions with Waterproofing Systems

- 1) Where two roof systems intersect, materials must be compatible with each other, or must be separated from contact by an intermediate separation layer.
- 2) When a *water-shedding system* transitions
  - 1) up a slope onto an upper *waterproofing system* (Figures **10.1** and **10.2**),
    - 1) the transition may be made with a headwall flashing in combination with a parapet, or with a metal edge termination (following the requirements for either one, as articulated in the relevant *waterproofing system* Standard).
    - 2) the waterproofing must be completed in accordance with the requirements found in **10.3.5.4 Transitions with Water-shedding Systems** of the relevant *waterproofing system* Standard.
  - 2) down a slope onto a lower *waterproofing system* (Figures **10.3** and **10.4**),
    - 1) the waterproofing must be completed in accordance with the requirements found in **10.3.5.4 Transitions with Water-shedding Systems** of the relevant *waterproofing system* Standard.
    - 2) shingles must be started with a *starter course*.

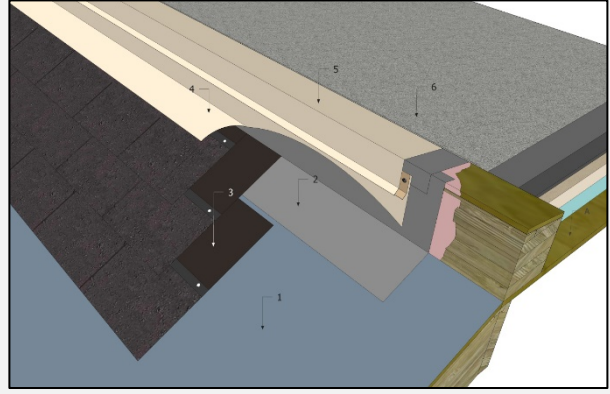
- 3) shingle *underlayment* must overlap the waterproofing flashing by no less than 100 mm (4").
- 4) the lowest course of shingles should terminate above the waterproofed roof no closer than 100 mm (4").

Click on an image below to view the related Construction Detail.

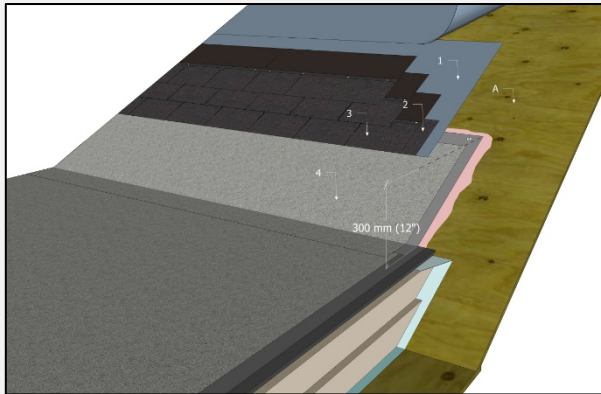
[Figure 10.1](#)



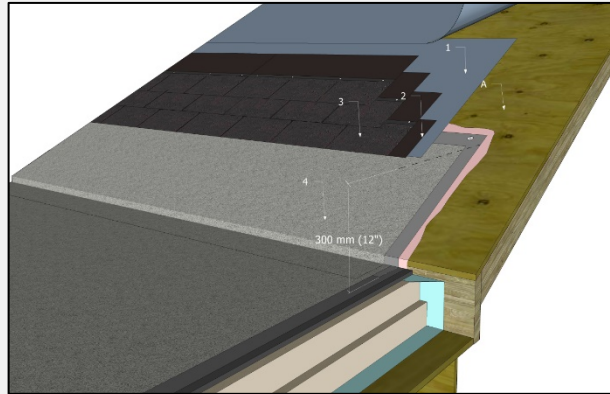
[Figure 10.2](#)



[Figure 10.3](#)



[Figure 10.4](#)



# 11 DRAINAGE and PENETRATIONS

## 11.1 General

This Part contains standards and references to membrane work that may be atypical of Asphalt Shingle System construction. These are nevertheless included to address situations where multiple types of roof systems intersect or overlap, or where membrane gutters are employed (see also **12.2 Built-in Membrane Gutters**). The reader is advised to read this Part with consideration to the entire scope of the Project design and its construction. Other Standards for *waterproofing systems* may also apply.

### 11.1.1 Definitions

#### **Curb**

means an elevated box or platform that is supported by the roof structure, is protected from the weather and is used to support or surround building mechanical units, chimney vents, skylights or structural anchor points. The front of a curb is defined as the side facing down the slope; the back of a curb is defined as the side facing up the slope.

### 11.1.2 Design

#### 11.1.2.1 [NOT USED]

#### 11.1.2.2 All Projects

- 1) The design and placement of *curbs*, for skylights or penetrations, shall be the responsibility of the *Design Authority*.
- 2) *Curbs* and penetration flashings are normally supplied or constructed by other trades but must be sealed by the *Contractor*.
- 3) *Curbs* for skylights and other equipment must be designed with a minimum height of 150 mm (6") above the *roof deck*. Proprietary deck-mounted skylights with *curb* profiles lower than the minimum must be capable of shedding water that flows over and around the skylight structure.
- 4) The surface of shingles must be protected from damage during the life of the roof, including damage by funneled water (such as water from rainwater leaders that spills directly onto another roof surface). Therefore, while external metal gutters are an accessory and are not covered by the **RoofStar Guarantee**, the roof design must incorporate means and methods, such as the use of rainwater gutters, leader extensions or other devices, for managing the flow of water from one roof surface to another and away from the building.
- 5) Penetrations
  - 1) must each be weatherproofed with a flashing.
  - 2) should be located away from valleys, but in any event must be situated so that the flange of the penetration flashing is at least 100 mm (4") away from the edge of metal valley pans.
- 6) 5-in-1 penetration flashings
  - 1) **are not recommended for new construction because their waterproofing installation relies on proper execution by other trades.**
  - 2) are permitted only when installed together with a properly fitted and caulked galvanized storm collar.

## 11.2 Materials

### 11.2.1 Membrane Flashing

- 1) Membranes used to flash (strip in) penetrations shall be the same material used for eave and valley protection. Refer to **8.2 Materials (EAVE PROTECTION and UNDERLAYMENT)**.

## 11.2.2 Roof Drains and Overflows

- 1) Drains and *overflows* used in membrane gutters may be found in any of the Standards for roof *waterproofing systems*. The reader is advised to consult the relevant standard for design, material and application requirements.

## 11.2.3 Penetration Flashings

- 1) Penetration flashings, regardless of their type, must be either
  - 1) proprietary to, or privately labeled for, the shingle manufacturer, or
  - 2) specifically accepted by the **RoofStar Guarantee Program**.

See also **6.2.2 Air Vents** for Attic Ventilation.

- 2) Penetration flashings should be selected for their ability to inhibit the intrusion of vermin and insects into the roof assembly and building interior.
- 3) Mechanical penetration flashings:
  - 1) Lead plumbing vent flashings must each be
    - 1) fabricated with sheet lead material weighing no less than 14.65 Kg/m<sup>2</sup> (3lb/sf).
    - 2) properly sized for the pipe.
    - 3) supplied with a settlement cap made from the same materials (the inside collar of the settlement cap must fit vertically inside the pipe opening by at least 1").
  - 2) All plastic or metal penetration flashings (including mechanical exhaust vents but excluding natural airflow vents) must be
    - 1) manufactured with materials and methods that meet or exceed the requirements set out in *CSA B272, Prefabricated Self-Sealing Roof Vent Flashings*.
    - 2) permanently marked with the Standard number.
    - 3) tested by an accredited third party to verify compliance with the required Standard.
    - 4) properly sized for the penetration, both in diameter and height.
    - 5) watertight and seamless or, in the alternative, fabricated with fully hot-welded joints.
    - 6) fabricated with a hot-welded or seamless flange at least 100 mm (4") wide, around the bottom of the flashing.
    - 7) flexible or sloped to suit the roof slope.
    - 8) fitted with a clamping galvanized storm collar or settlement cap.

These flashings include, without limitation, galvanized B-vent and polymeric flashings.

- 3) 5-in-1 flashings (flashings manufactured with Thermoplastic Elastomers, or TPE) must be
  - 1) manufactured with materials and methods that meet or exceed the requirements set out in *CSA B272, Prefabricated Self-Sealing Roof Vent Flashings*.
  - 2) permanently marked with the Standard number.
  - 3) tested by an accredited third party to verify compliance with the required Standard.
  - 4) properly sized for the penetration.
- 4) Natural air flow vents must be
  - 1) Type B or C ventilators manufactured to conform to or exceed the requirements set out in *CAN3-A93-M82 (R2003) Natural Airflow Ventilator for Buildings*.
  - 2) permanently marked with the standard number.
  - 3) tested by an accredited third party to verify compliance with the required Standard.
  - 4) fabricated from plastic or corrosion-resistant metal (painted or unfinished).
  - 5) manufactured with a base flange that measures
    - 1) at least 75 mm (3") wide on the up-slope side of the flashing.
    - 2) at least 50 mm (2") along the vertical sides, and along the bottom side of the flashing.



- 5) Sheet lead flashings must be fabricated with sheet lead material weighing no less than 14.65 Kg/m<sup>2</sup> (3lb/sf).
- 6) B-vent and plumbing vent flashings must be at least 200 mm (8") in height, measured vertically from the *drainage plane* to the opening or top of the flashing.
- 7) Goose-neck flashings must be fabricated to accommodate environmental conditions (wind and snow).
- 8) Storm collars must be fabricated so that they slope downward approximately 45° from the penetration and are at least 50 mm (2") wide.
- 9) Chimney chase caps must be
  - 1) galvanized metal meeting the material standards for metal flashings in **Part 13**.
  - 2) soldered at all joints in the water plane.
  - 3) fabricated with slope to shed water.

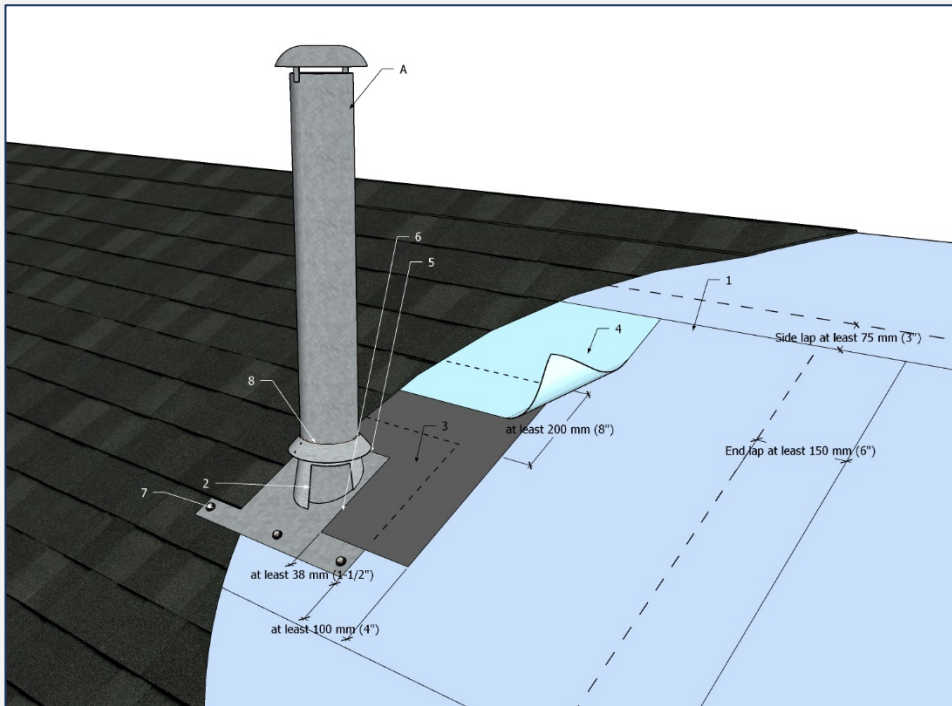
## 11.3 Application

### 11.3.1 General

- 1) The standards in this Part may not include every possible detail the *Contractor* will encounter, but every installation must be executed in keeping with the following:
  - 1) Every transition in plane must be flashed (under-laid) with a non-adhering *underlayment* or a self-adhering membrane; the choice is slope-dependent and at the discretion of the *Design Authority*, but in any event is subject to the requirements in **Part 8 EAVE PROTECTION and UNDERLAYMENTS**.
  - 2) The *underlayment* below shingles, regardless of its type, serves as the final water barrier above the *roof deck*.
  - 3) All materials must be installed in overlapping layers that positively shed water to a lower surface; asphalt shingles must be installed to provide double coverage.
  - 4) Materials must be secured in accordance with various Parts in this Standard.
  - 5) Water must be allowed to flow freely off the roof.
  - 6) Nails must never be exposed to water.
- 2) All penetration and *linear metal flashings* must be separated from the underlying substrate with *underlayment* or a self-adhering *eave protection* membrane. See **Part 8 EAVE PROTECTION and UNDERLAYMENTS**.
- 3) The flange of any penetration flashing must be at least 100 mm (4") away from the edge of metal valley pans.
- 4) Where self-adhered membranes are installed around penetrations,
  - 1) the flashing flange must be sealed to the *roof deck* with a horseshoe patch of self-adhering membrane that
    - 1) extends up the slope at least 200 mm (8") past the top of the flange, overlapped by the next (upper) course of underlayment.
    - 2) extends downslope from the opening at least 50 mm (2").
    - 3) extends onto the side flanges by at least 38 mm (1 ½") and beyond the sides of the flange by at least 100 mm (4").
    - 4) provides a drainage path
      - 1) of 12 mm (1/2") around the sides of the penetration upstand.
      - 2) of 19 mm (3/4") around the top of the penetration upstand.
  - 2) membrane overlaps must be hand-rolled with a membrane manufacturer's accepted roller or otherwise fully bonded.

See **Figure 11.3.1-1**.

[Figure 11.3.1-1](#) (click on image for Construction Detail)



- 5) *Linear metal flashings* used at walls, curbs or other vertical surfaces must be installed behind (covered with) any control layers, finish materials and counterflashings.
- 6) Shingles installed around a flanged penetration flashing or curb step flashings must
  - 1) be nailed outside the flange of a plastic vent; nailing through a metal flange is permissible (NOTE: when the flange is wider than 100 mm (4"), the shingle overlap must be manually tabbed).
  - 2) maintain double coverage.
  - 3) provide a drainage path of no less than 6 mm (1/4") and no more than 12 mm (1/2") between the edge of the shingles and the sides of the penetration or curb.
- 7) Where fasteners may be exposed to the weather, only cladding fasteners (screws) with gasketed washers may be used. See **13.2.3 Fasteners**.
- 8) When installing heat-welded membranes, or where construction sequencing requires it, alternatives to conventional membrane flashing should be considered. Refer to **11.3.3.2 Alternative Membrane Flashing Approaches** in the **SBS-Modified Bitumen Membrane Roof Systems** Standard.

## 11.3.2 Roof Drains and Drainage

### 11.3.2.1 General

- 1) For the application of roof drains, refer to **Part 11** in the applicable roof *waterproofing system* Standard.

### 11.3.2.2 [NOT USED]

### 11.3.2.3 [NOT USED]

### 11.3.2.4 [NOT USED]

### 11.3.2.5 [NOT USED]

### 11.3.2.6 External Metal Gutters

- 1) Gutters and downspouts are not covered by the **RoofStar Guarantee**.

- 2) Notwithstanding other standards in this Part, when a roof drains onto another roof, the drainage of water must be controlled to eliminate abrasion or erosion from water flow. **The use of splash pads, when appropriate for the location, is strongly recommended.**
- 3) The use of downspouts, installed by the *Contractor* or other trades and laid directly against the slope of the roof to connect an upper roof drainage to lower gutters, is acceptable under the **RoofStar Guarantee Program**, provided the material is strongly secured both at the top and the bottom. The use of a spillway flashing is optional.

## 11.3.2 Penetrations and Vents

### 11.3.3.1 [NOT USED]

### 11.3.3.2 All Projects

- 1) Penetration flashings must be located at least 200 mm (8") away from any adjacent penetration, upstand, edge or wall. The separation space is measured between openings, excluding the flange.
- 2) Each roof penetration must have its own flashing (except where a purpose-made flashing is designed for multiple penetrations), and must
  - 1) be suitable for the slope and penetration.
  - 2) be properly fitted to form or permit a seal around the penetration.
  - 3) incorporate properly fitted settlement caps (where applicable).
  - 4) not be used with multiple pipe roof penetrations.
- 3) All flanged vent and penetration flashings must be
  - 1) flashed in with a self-adhering *eave protection* membrane 'horseshoe' as described in **11.3.1 General**.
  - 2) located no closer to the ridge than 300 mm (12"), or two courses of shingles, whichever is greater.
  - 3) secured to the roof deck:
    - 1) When the flashing is supplied with pre-drilled or moulded nail and screw holes, use nails where the fasteners are covered by shingles; use gasketed screw where fasteners will be exposed.
    - 2) When the flashing does not have any pre-drilled or moulded fastening holes, place
      - 1) nails in the top corners of flashing flange, and at the mid-point on either side of the flange, keeping nails 12 mm (1/2") from the edge.
      - 2) screws in the bottom flange - one fastener centred below the flashing upstand when it is 200 mm (8") or less in width, or two fasteners when the flashing body is wider.
- 4) Plastic vent flashings shall not be used
  - 1) for combustion or grease laden venting.
  - 2) in combination with solvent-based primers, cements or mastic.
- 5) 5-in-1 flashings
  - 1) **are not recommended for new construction because their waterproofing installation relies on proper execution by other trades.**
  - 2) are permitted only when installed together with a properly fitted and caulked galvanized storm collar.
  - 3) must be installed together with a properly fitted and caulked galvanized storm collar. When used for new construction, the plumbing trade must ensure the
    - 1) flashing is not distorted.
    - 2) storm collar is securely fitted and sealed.
- 6) When a pipe-type penetration extends above the top edge of the roof flashing, the penetration must be fitted with at least one galvanized clamping storm collar; seal the top edge of the collar with an evenly applied, untooled bead of sealant at least 10 mm (3/8") wide. When a double storm collar is specified, the collars must be approximately 25 mm (1") apart, and each must be independently sealed.

- 7) Where a purpose-made flashing does not fit the penetration, the joint between the penetration and the flashing must be sealed using one of the following methods:
  - 1) Fit a site-formed non-bituminous flexible roof membrane storm collar and secure it to the flashing and penetration with stainless steel clamps.
  - 2) Apply a shrink-wrapped termination secured with a stainless-steel mechanical compression strap.Regardless of the method, sealant must be applied between the penetration and the collar or shrink-wrapping.

#### 11.3.4 Curbs

- 1) All *curbs* incorporated into the *water-shedding system* must be
  - 1) no less than 150 mm (6") in height above the roof *deck*.
  - 2) fully flashed with a self-adhered underlayment membrane, which must extend to the top of the *curb*. Where possible, the membrane should extend across the top of the *curb* and terminate on the vertical inside face.
  - 3) flashed on all sides with the following metal flashings, which must be fabricated, seamed and secured in keeping with **13.3 Application**:
    - 1) An apron flashing at the bottom.
    - 2) Step flashings on the sides.
    - 3) A backpan, cricket or membrane-covered cricket installed at the top.
- 2) The top edge of all metal flashings must be protected from exposure to the weather with
  - 1) *curb wall* finishes.
  - 2) equipment flashings.
  - 3) metal counterflashings.
- 3) Apron flashings must
  - 1) be secured to the *wall* or secured with gasketed screws into the *roof deck*.
  - 2) be wrapped around the sides of the curb by at least 100 mm (4") (see **Figure 13.8**).
  - 3) precede the installation of step flashings along the sides of the *curb*.
- 4) Only new step flashings are permitted (cloning is not allowed), and step flashings shall
  - 1) extend at least 75 mm (3") downslope from the corner of a vertical surface (*wall* or *curb*) and have a 75 mm (3") head-lap above the shingle exposure.
  - 2) be placed flush with the butt edge (bottom) of each asphalt shingle course.
  - 3) fastened through the deck flange of the flashing with nails placed 50 mm (2") and 25 mm (1") in from the outside edge.
  - 4) fold around the top face of a *curb* and extended upslope, behind and beneath the backpan.
- 5) Where step flashings are used, a drainage path of no less than 6 mm (1/4") and no more than 12 mm (1/2") must be provided between the edge of the shingle and the vertical face of the step flashing.
- 6) Backpans must be installed to overlap step flashings, and must be fastened
  - 1) into the *curb* through the flashing upstand.
  - 2) into the roof *deck* along the top edge of the backpan, and 300 mm (12") down from the top of the backpan, on either side.
- 7) *Curbs* with widths
  - 1) up to 900 mm (36") must be flashed at the top with a backpan (see **13.3.1 Fabrication**).
  - 2) between 900 mm (36") and 1200 mm (48") must be constructed with a metal saddle (*cricket*) that
    - 1) is supported by rigid material to prevent metal distortion.
    - 2) is integrated with the *curb* or chimney flashings.
    - 3) extends up-slope from the back of the *curb*, beneath the shingles and underlayment to a point at least 150 mm (6") (when measured vertically) from the base of the *curb*.
    - 4) has flanges which lap under the metal *curb* flashing at least 50 mm (2").

- 5) is closed at any seams with either of the following:
- 1) welds.
  - 2) blind rivets, incorporating two beads/rows of sealant.
- 3) over 1200 mm (48") must be designed and constructed with a waterproofing membrane installed over a rigidly constructed *cricket*; the membrane must extend 150 mm (6") laterally past the *curb* corner and extend 75 mm (3") down the face of the roof deck, overlapping shingles. See **Part 12** for built-in membrane gutters. See also **10.3.5.2.5 Dead Valleys and Valley Transitions**.
- 8) Shingles above the flange of a backpan or metal *cricket* must be installed
- 1) at least 50 mm (2") up slope from the *curb* or *cricket*.
  - 2) secured to the roof deck no less than 200 mm (8") up slope from the *curb* or *cricket*.
- 9) Masonry chimneys must incorporate counterflashings
- 1) that overlap the apron flashing, step flashings and backpan.
  - 2) installed in a raked joint or cut reglet at least 25 mm (1") deep and finished with sealant or mortar (see *British Columbia Building Code, 9.26.4.4 Intersection of Shingle Roofs and Masonry*).
- 10) Skylights
- 1) installed on *curbs* meeting the minimum height requirements (see **11.1.2 Design**) must be waterproofed and flashed in keeping with the standards for *curbs*.
  - 2) with proprietary *curbs* must, regardless of their height, be sealed to the roof *deck* following the standards for penetration and vent flashings.
-

## 12 OTHER DETAILS

### 12.1 Photovoltaic and Solar Water Panels

#### 12.1.1 Design

- 1) No photovoltaic (PV) or solar water panels may be mounted on water-shedding roofs with a slope less than 1:4 (3" in 12").
- 2) All PV or solar water panels shall be
  - 1) **engineered for securement to the structure** against wind uplift.
  - 2) deck-mounted at least 150 mm (6 inches) from the surface of the *drainage plane*.
  - 3) supported with hardware installed in keeping with the standards for penetration flashings in **Part 11 DRAINS and PENETRATIONS**.

#### 12.1.2 Materials

(Under development)

#### 12.1.3 Application

- 1) All PV or solar water panels shall be installed in keeping with the standards for penetration flashings in **Part 11 DRAINS and PENETRATIONS**.

### 12.2 Built-in Membrane Gutters

#### 12.2.1 Design

- 1) When a built-in membrane gutter adjoins a RoofStar-guaranteed *water-shedding system*, the gutter waterproofing must be constructed by the roofing *Contractor* to be included by the **RoofStar Guarantee**. Built-in membrane gutters that drain a roof not covered by a **RoofStar Guarantee** are not eligible for a **RoofStar Guarantee**.
- 2) Insulated *water-shedding systems* that drain into a built-in gutter must abut solid blocking at the gutter edge that provides
  - 1) a stop for the insulation *assembly*.
  - 2) a solid substrate for the securement of flashings and membranes.
- 3) The *Design Authority* is responsible to design the gutter for its anticipated capacity, with consideration given to
  - 1) rainfall and snow load calculations for the building location.
  - 2) drain type, size and flow rate.
  - 3) size and placement of the *overflow drain*.

For rainfall and snow load capacities, refer to the *British Columbia Building Code, Div. B, Appendix C, Table C-2* which lists various types of loads, including rain and snow loads, for specific reference locations throughout the province.

- 4) Only fully adhered membranes or acceptable metal gutter liners may be used in built-in gutters.
- 5) The gutter membrane must be designed to extend up the slope (when measured vertically from the maximum water level)
  - 1) at least 150 mm (6").
  - 2) at least 300 mm (12") in regions with typical heavy snow.

or to a point (when measured vertically) at least 600 mm (24") from the inside face of the exterior *wall* of the building.

- 6) New gutters shall be designed with a minimum width of 300 mm (12") and a depth not exceeding the gutter's width. At least 100 mm (4") clearance on the horizontal plane is required between any gutter *wall* and the

- 1) the edge of the drain bowl for spun drains.
- 2) the edge of the drain leader for flat spun or welded drains.

Cast drains must be installed according to the requirements set out in **11.3.2 Roof Drains**.

- 7) To qualify for a **RoofStar Guarantee**, existing gutters should be redesigned if their capacity is undersized but must nevertheless incorporate an overflow drain in keeping with the requirements in this Part. Where the primary drain in an existing gutter is undersized for the capacity of the gutter, the primary drain must be replaced with a properly sized drain.
- 8) An *overflow drain* must be located at least
  - 1) 100 mm (4") above the primary gutter drain.
  - 2) 25 mm (1") below any mechanical fasteners used to secure the adjoining *roof system*.
- 9) For transitions between the built-in gutter and *water-shedding systems*, refer to **10.3.5.4 Junctions with Waterproofing Systems**.

## 12.2.2 Materials

NOTE: These material standards are applicable to membrane gutters for all membrane-based *waterproofing systems*; hence, references to various membrane types.

- 1) Only EPDM, PVC, TPO, 2-ply modified bituminous membranes or reinforced PMMA are acceptable for this application:
  - 1) Single-ply non-bituminous membrane thickness must be no less than 60 mils (1.524 mm).
  - 2) 2-ply bituminous membranes must meet the minimum thickness requirements in **9.2.1 Composition, Thickness and Selection (RoofStar Guarantee Standards for SBS Modified Bitumen Systems)**.
  - 3) Reinforced PMMA liquid membrane systems approved for field use, applied on an accepted SBS-modified base membrane.
- 2) A metal gutter liner may be fabricated from
  - 1) copper sheet material, incorporating soldered seams.
  - 2) stainless steel, incorporating welded seams.

See **13.2.1 Sheet Metal Grade and Gauge** for gauge requirements. See also Application below.

## 12.2.3 Application

- 1) All gutter membranes must be installed according to the membrane manufacturer's published instructions.
- 2) Gutter membranes must be
  - 1) installed perpendicular to the gutter length.
  - 2) carried up an adjoining *water-shedding system* (measured vertically from the maximum water level)
    - 1) at least 150 mm (6"), or
    - 2) at least 300 mm (12") in regions with typical heavy snow, or
    - 3) (when specified), to a point (when measured vertically) at least 600 mm (24") from the inside face of the exterior *wall* of the building.
  - 3) lapped under and sealed to the adjoining membranes at least 150 mm (6").
  - 4) installed in keeping with Application requirements in this Standard.
- 3) Gutter membranes must be mechanically secured at their terminations, both on the outside of the gutter edge and on the field. Fasteners securing the membrane on the field must be placed at least 150 mm (6") above the maximum water level. Securement fastener spacing shall be no more than 300 mm (12") O.C.
- 4) Gutter drains and *overflows* must be installed in keeping with the design requirements outlined in **12.2.1 Design**. Drain flanges that are bent to accommodate the side *walls* of the gutter must be mechanically fastened to the gutter *wall* before membrane application. Refer to the requirements for roof drains in any of the Standards for roof *waterproofing systems*.
- 5) A metal gutter liner
  - 1) fabricated from copper sheet material must incorporate soldered seams.
  - 2) fabricated from stainless steel must incorporate welded seams.

- 3) must be installed
    - 1) over an adhered single-ply membrane no less than 2.3 mm (bituminous membranes) or 60 mils (non-bituminous membranes).
    - 2) with a *separation layer* between the membrane and the metal liner to prevent damage to the membrane caused by the liner at its joints.
  - 6) When an adjoining *water-shedding system* is insulated (typically ASM only), the transition from gutter to the *water-shedding system* may require the use of tapered insulation incorporating a drainage plane between layers of tapered insulation. See [ASM 12.1.2 Built-in Gutter Assembly](#) for an illustrated example.
-



# 13 METAL FLASHINGS

## 13.1 General

This Part pertains to *linear metal flashings* (different from penetration or ventilation flashings), fabricated from sheet metal in various lengths (segmented) and designed to divert water away from vulnerable surfaces (such as walls), or off the roof into a drainage system. *Linear metal flashings* also provide an aesthetic finish to the *roof system*. *Linear metal flashings* are not a waterproofing component but are integral to the water-shedding function of the roof system.

Refer also to **Part 10 PERIMETERS and WALLS** and **Part 11 PENETRATIONS, CURBS and DRAINAGE**.

*Linear metal flashings* include, without limitation,

- Eave and rake edge flashing
- Counterflashing
- Step and Diverter flashing
- Head wall flashing
- Fascia flashing
- Valley flashing
- Spillway flashing

### 13.1.1 Definitions

Refer to the [Glossary](#) for further definitions of key terms used in this *Manual*.

### 13.1.2 Design

- 1) *Linear metal flashings* described in any Part of this Standard are considered necessary and integral to the scope of a *project* designed and constructed to qualify for a **RoofStar Guarantee**. Furthermore, only new *linear metal flashings* may be specified and installed; reuse of any existing *linear metal flashings* is prohibited and may void the *Guarantee*. See also **1.6 RoofStar Guarantee: Coverage and Limitations**.
- 2) The *Design Authority* must specify
  - 1) metal type, painted finish and gauge (no less than 24-gauge)
  - 2) seam types (if required).
  - 3) length of flashings (if different from the requirements published in this Standard).
  - 4) method of attachment (concealed or exposed fasteners).
- 3) Design drawings must detail metal flashing profiles desired for the *project*.
- 4) Roof materials that are UV-sensitive must be protected with metal flashings.
- 5) Where a *water-shedding system* adjoins a *waterproofing system*, *linear metal flashings* used at the adjoining details must conform to the standards in **Part 13 METAL FLASHINGS** for the applicable roof *waterproofing system*.
- 6) Where a parapet meets a *water-shedding system*, the *parapet* shall be waterproofed in accordance with the requirements of the applicable Standard. See also **10.3.6 Junctions with Waterproofing Roof Assemblies**.
- 7) For *linear metal flashings* applied to *waterproofing systems*, see **Part 13 METAL FLASHINGS** in the applicable roof *waterproofing systems* Standard.

## 13.2 Materials

- 1) *Linear metal flashings* must be new, manufactured and supplied by the *Contractor* or by an Associate Member of the RCABC, and must conform to the requirements published in this Part. See also **1.6 RoofStar Guarantee: Coverage and Limitations**.

### 13.2.1 Sheet Metal Grade and Gauge

- 1) A mill certificate must be provided by the *Contractor* when requested by the *Design Authority*.

2) The following minimum gauges and / or weights of commonly used metals or alloys are acceptable for use in the **RoofStar Guarantee Program**.

1) **Sheet Steel Materials**

- 1) Aluminum-zinc alloy coated steel sheet, 0.6858 mm (0.027", 24-gauge) thick, conforming to *ASTM A792 / A792M-06* SS Grade 33, *AZM150 (AZ50)* coating. Thickness tolerance as per *ASTM A924 / A924M-06*  $\pm 0.08$  mm (0.003") for sheet widths not exceeding 1500 mm (60").
- 2) Galvanized steel sheet, 0.6858 mm (0.027", 24-gauge) thick, conforming to *ASTM A653 / A653M-06* SS Grade 33, *Z275 (G90)* coating. Thickness tolerance as per *ASTM A924 / A924M-06*  $\pm 0.08$  mm (0.003") for sheet widths not exceeding 1500 mm (60").
- 3) Stainless steel sheet, 0.38 mm (0.014", 28-gauge) stainless steel, Type 302, 304, 316, 2B finish to *ASTM A167-82*. Maximum thickness tolerance variation  $\pm 0.04$  mm (0.0015") based on 1200 mm (48") wide sheet.

2) **Non-Ferrous Materials**

- 1) Aluminum sheet, 0.80 mm (0.032", 20-gauge) aluminum sheet, utility quality to *CSA HA Series - 1975*, plain or embossed finish. Maximum thickness tolerance variation  $\pm 0.06$  mm (0.0025") based on 1200 mm (48") wide sheet.
- 2) Copper sheet, 0.56 mm (.0216" 16 oz.) thick, cold rolled roofing copper to *ASTM B370-91*. Maximum thickness tolerance  $\pm 0.04$  mm (0.0015).
- 3) Zinc sheet, 0.81 mm (0.031")  $\pm 0.03$  mm thick, conforming to *European Standard EN 988-1996*. Zinc grade Z1 conforming to *EN 1179* that is 99.995% minimum zinc content, with addition of copper-titanium alloys. Maximum thickness tolerance variation  $\pm 0.03$  mm (0.0012").

The *Design Authority* should indicate the type and gauge of metal required, as well as the qualifying standards. The reference standard for gauges is USS REV (metric in mm).

### 13.2.2 Pre-painted Finishes

- 1) When a painted finish on metal flashing is specified, only SMP and PVDF pre-painted finishes are acceptable.
- 2) Where an Architectural Sheet Metal System adjoins an Asphalt Shingle System, connecting *linear metal flashings* must have the same finish as the metal panels.

### 13.2.3 Fasteners

- 1) Nails are acceptable as fasteners, unless otherwise specified by the *Design Authority* or prohibited by the requirements in this Standard.
- 2) All threaded fasteners used to secure *linear metal flashings* must be #8 corrosion-resistant screw or expansion fastener with a low-profile head and must be compatible with both the metal flashing material and the substrate.
- 3) Cladding fasteners (screws) with gasketed washers, used as exposed fasteners for metal flashing, must be No. 8 or larger, and must be made of metal compatible with, and corresponding in colour to, the flashing material.
- 4) Blind rivets may be used for securing two metal flashings together.

### 13.2.4 Sealants

- 1) Sealants shall be
  - 1) non-hardening high-quality butyl or polyurethane.
  - 2) available in either gun grade or sealant tape form.
  - 3) suitable for exterior use and able to resist the effects of weathering.

Page **50** of **56**

**RoofStar Guarantee Standards**

for Asphalt Shingle Systems

Updated February 2021

© RCABC 2021

No reproduction of these Standards, in whole or in part, is lawful without the expressed permission of the RGC Guarantee Program.

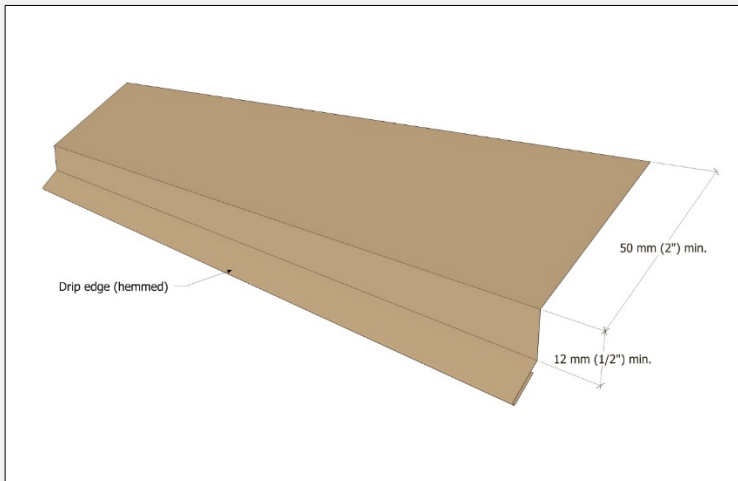
- 4) compatible with, and able to adhere to, the materials to which they are applied.
- 2) Sealants shall conform to any one of the following:
  - 1) CGSB 19-GP-5M, "Sealing Compound, One Component, Acrylic Base, Solvent Curing".
  - 2) CAN / CGSB-19.13, "Sealing Compound, One Component, Elastomeric, Chemical Curing".
  - 3) CGSB 19-GP-14M, "Sealing Compound, One Component, Butyl-Polyisobutylene Polymer Base, Solvent Curing".
  - 4) CAN / CGSB-19.24, "Multi-Component, Chemical Curing Sealing Compound".

## 13.3 Application

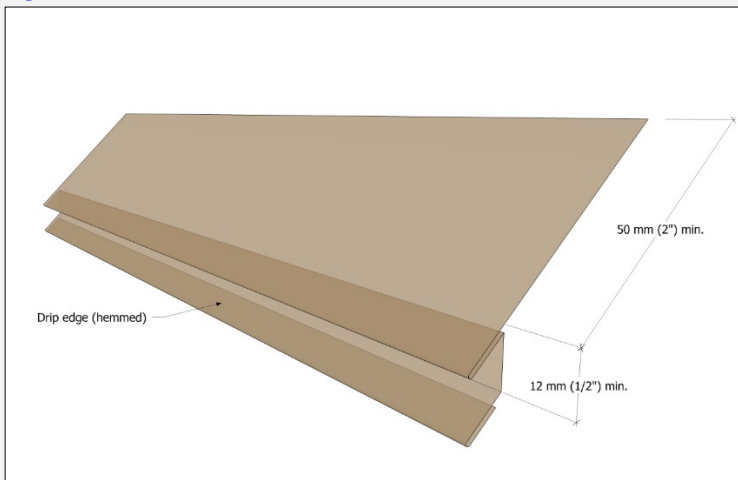
### 13.3.1 Fabrication

- 1) *Drip edges* are not required but are strongly recommended for flashings around the outside perimeter of a building, to protect wall finishes. When *drip edges* are used they must extend at least 12 mm (1/2") from the vertical face.
- 2) Eave and rake edge flashings (**Figure 13.1**) must be fabricated with a
  - 1) leg that extends onto the supporting deck surface at least 50 mm (2").
  - 2) vertical leg that is bent to suit the slope, extending down the outside edge of the *roof deck* at least 12.5 mm (1/2").

**Figure 13.1a** (Note: not all typical materials are shown)

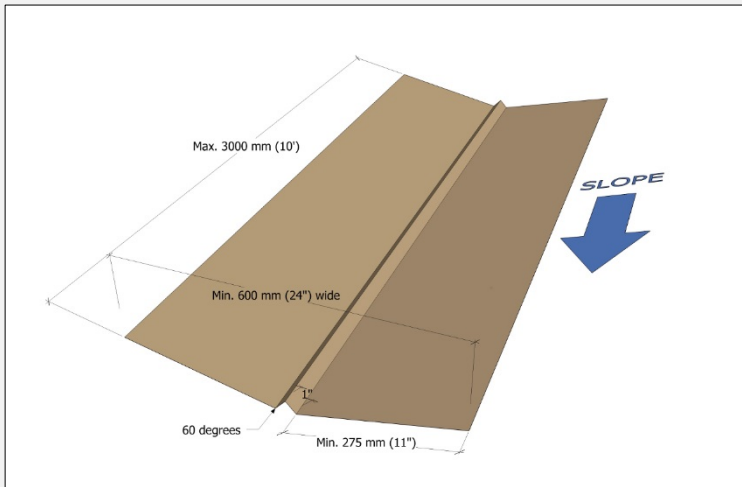


**Figure 13.1b** (Note: not all typical materials are shown)

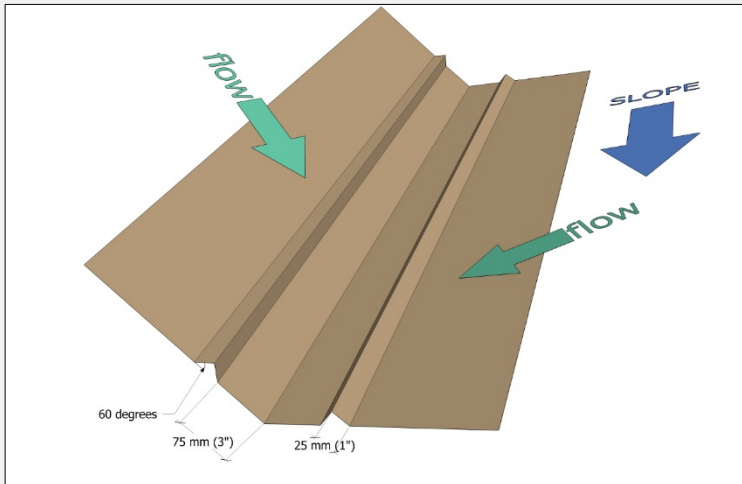


- 3) Valley flashing (**Figure 13.2** and **Figure 13.3**) must be
- 1) at least 600 mm (24") wide.
  - 2) no more than 3000 mm (10') in length.
  - 3) fabricated with
    - 1) a centre diverter (W profile), folded to a maximum of 60° (degrees) on the inside angle of the divider, at least 25 mm (1") in height.
    - 2) double diverters, located 75 mm (3") from the valley pan centreline, when a *Steep Slope* roof drains onto a *Common Slope* or *Low Slope* roof surface.

**Figure 13.2** (Note: not all typical materials are shown)



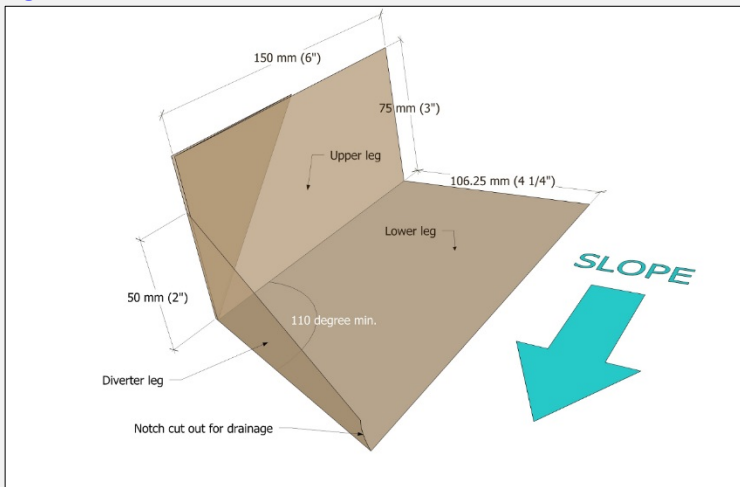
**Figure 13.3** (Note: not all typical materials are shown)



- 4) Water diverter flashings (**Figure 13.4**), when used together with a step flashing at a wall, must be folded bread-pan fashion (not cut, riveted or welded), and must
- 1) be at least
    - 1) 75 mm (3") in height above the surface of the *drainage plane*.
    - 2) 150 mm (6") in length at the top of the vertical leg.
  - 2) incorporate an upstanding diverter leg
    - 1) bent at the downslope end of the flashing

- 2) that extends downslope at least 110°.
- 3) no less than 50 mm (2") in height where the diverter leg intersects the vertical face of the flashing.
- 4) notched at the outer corner to form an outlet for drainage.

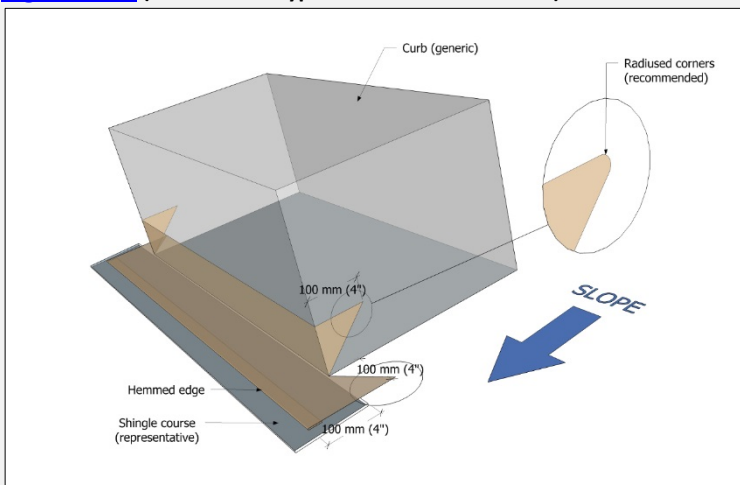
**Figure 13.4** (Note: not all typical materials are shown)



See Construction Detail **E2.7.11** for an illustrated guide.

- 5) Apron flashings (**Figure 13.5**) must be
  - 1) fabricated to extend
    - 1) laterally past the sides of the curb or chimney, and to fold back along its sides, by at least 100 mm (4").
    - 2) downslope from the curb or chimney 100 mm (4").
  - 2) over-broken (bent) so that the lower flashing leg extending onto the roof field will rest on the shingles under slight tension.

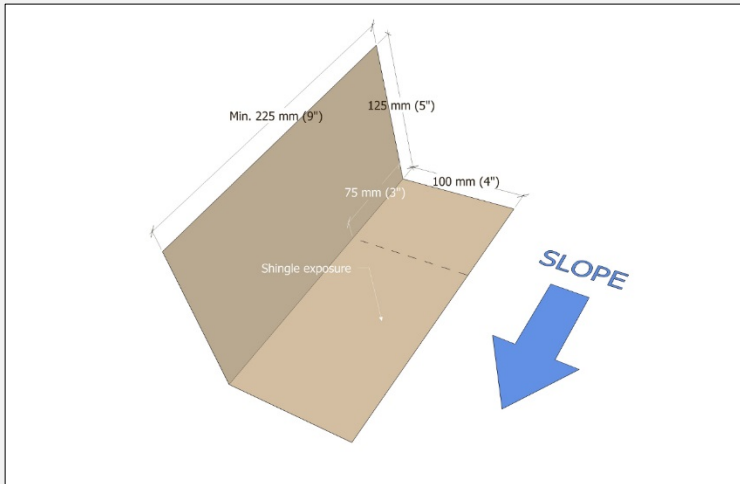
**Figure 13.5** (Note: not all typical materials are shown)



- 6) Step flashings (**Figure 13.6**) must be
  - 1) at least 125 mm (5") in height above the surface of the *drainage plane*.
  - 2) at least 100 mm (4") in width.

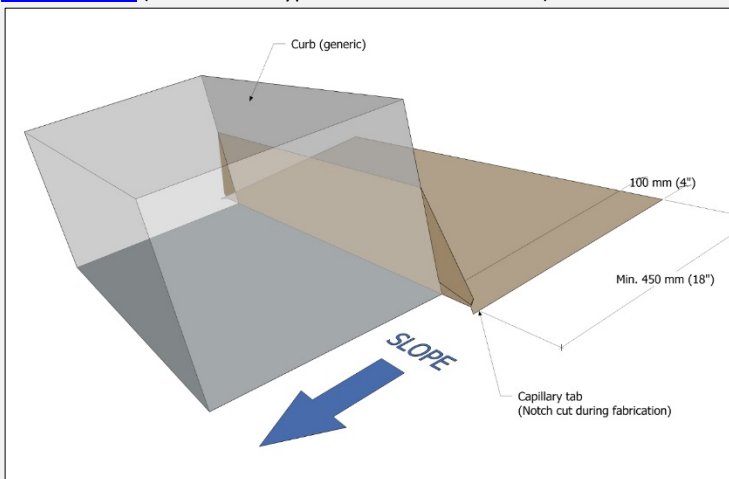
- 3) at least 225 mm (9") in length, or fabricated to match the shingle exposure plus 75 mm (3"), whichever is greater.

**Figure 13.6** (Note: not all typical materials are shown)



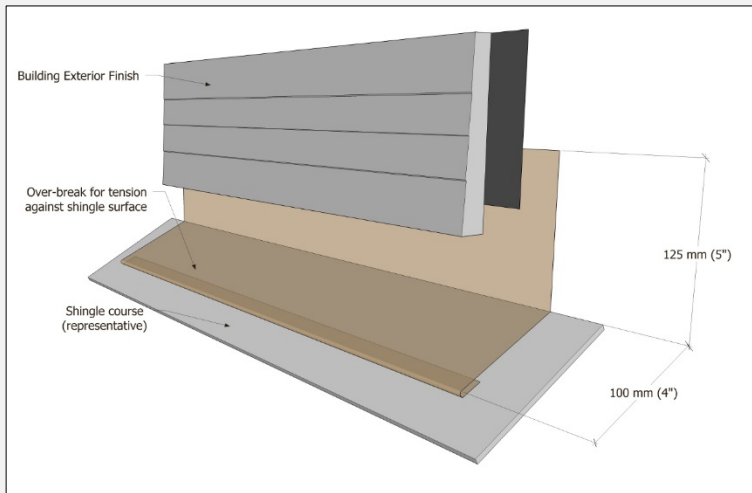
- 7) Backpan flashings (**Figure 13.7**) must be fabricated
  - 1) to extend at least
    - 1) 150 mm (6") up vertical surfaces.
    - 2) 450 mm (18") up the slope of the roof *deck* (for roof slopes less than 1:3 (4" in 12"), follow the requirements for chimney saddles in *British Columbia Building Code, 9.26.4.8 (5) Chimney Saddles*).
    - 3) 100 mm (4") laterally past the *curb* corners and folded downslope at an angle, not cut.
  - 2) with a capillary cut-out measuring between 3 mm (1/4") and 6 mm (1/2"), notched into the bottom outside corner of each side extension.

**Figure 13.7** (Note: not all typical materials are shown)



- 8) Head wall counterflashings (**Figure 13.8**) must be
  - 1) fashioned to the same height and width dimensions as a step-flashing.
  - 2) hemmed at the edge of the exposed leg.
  - 3) over-broken (bent) so that the lower flashing leg extending onto the roof field will rest on the shingles under slight tension.

**Figure 13.8** (Note: not all typical materials are shown)



### 13.3.2 Securement and Seams

- 1) Unless otherwise stated in this Standard, all *linear metal flashings* (except step flashings)
  - 1) must be secured with at least two (2) fasteners, or with fasteners placed no more than 450 mm (18") O.C. (see also **Part 10 PERIMETERS and WALLS** or **Part 11 DRAINAGE and PENETRATIONS**).
  - 2) in protected locations may be secured with nails or threaded fasteners that penetrate the substrate at least 19 mm (3/4").
  - 3) in exposed locations must be secured with cladding fasteners.
- 2) When nails are used to secure *linear metal flashings*, they must be
  - 1) covered by other (*wall* or *curb*) materials, or by adjacent flashings, and may not be left exposed to the weather.
  - 2) installed at least 25 mm (1") above the bottom edge of expected *wall* or *curb* finishes.
- 3) With the exception of metal valley flashings, *linear metal flashings* may be overlapped rather than seamed. Each overlap must be no less than
  - 1) 100 mm (4") when fully caulked in the lap.
  - 2) 150 mm (6") when installed without caulking in the lap.
- 4) When hidden metal clips are specified, they must
  - 1) be fabricated from no less than 26-gauge flat metal stock.
  - 2) be fastened no more than 75 mm (3") from the return (connecting hook).
  - 3) engage the flashing by no less than 12 mm (1/2").
- 5) Sealants must be tooled to positively shed water.

14 [NOT USED]

---

END OF STANDARD

Page 56 of 56

**RoofStar Guarantee Standards**

for Asphalt Shingle Systems

Updated February 2021

© RCABC 2021

No reproduction of these Standards, in whole or in part, is lawful without the expressed permission of the RGC Guarantee Program.